



nexus
interiors
— australia

VOL 14 2018

12/324 Settlement Road,
Thomastown, VICTORIA 3074

P: 03 9348 2000

F: 03 8677 2899

sample@nexusinteriors.com.au

EXPRESS CATALOGUE 2018
NEXT DAY DELIVERY

WORKSTATIONS - FURNITURE - SEATING - STORAGE - ACCESSORIES

WWW.NEXUSINTERIORS.COM.AU

* Order before 2pm and receive the following business day
Subject to stock availability

nexus
interiors
— australia



CONTENTS

VOLUME 14

PAGES

4 - 6	RAPID INFINITY
7	RAPID WIRING
8 - 11	RECEPTION & LOUNGE
12 - 15	RAPID SCREEN
16 - 19	RAPID SPAN WHITE
20 - 23	RAPID SPAN BEECH
24 - 26	TABLES
27 - 30	HEIGHT ADJUSTABLE WORKSTATIONS
31	MONITOR ARMS
32 - 33	RAPID VIBE
34 - 35	RAPID WORKER
36 - 37	RAPID MANAGER
38 - 40	MESH CHAIRS
41 - 43	OPERATOR CHAIRS
44 - 45	VISITOR CHAIRS
46 - 47	EXECUTIVE CHAIRS
48	CONFERENCE & EVENTS
49	HOSPITALITY
50	OTTOMANS
51	ACCESSORIES
52 - 56	STEEL STORAGE

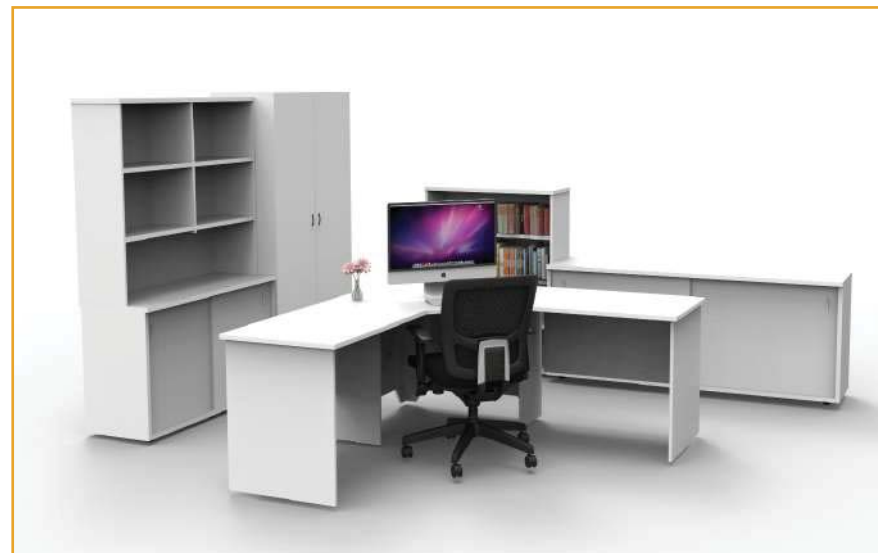

The Rapid Infinity Bench Workstation System



Select the Loop End Leg for a Distinctive, Premium Finish.

Pinable Black Screen provides Privacy whilst also Reducing Noise.

ASK FOR A QUOTE & FLOOR PLAN

Profile 60 x 30mm End Leg Creates Simple, Clean Lines.



Double Telescopic Rail for Rigid Support.

Recessed Intermediate Leg for Maximum Leg Space.

Choose from the Profile or Loop Leg.



Rapid Infinity

Maximise floor space and leg room with the stylish Rapid Infinity bench workstation system. Choose between two different end leg styles and include screens to create clean, space efficient workstation runs suitable for single, up to large numbers of users.



WORKSTATION TOP SIZES

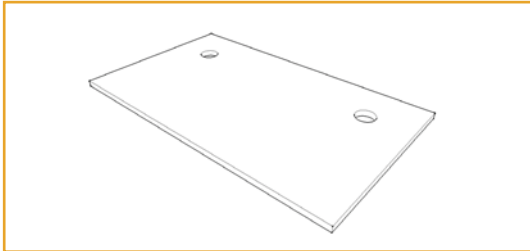

1200mm W x 700mm D x 25mm

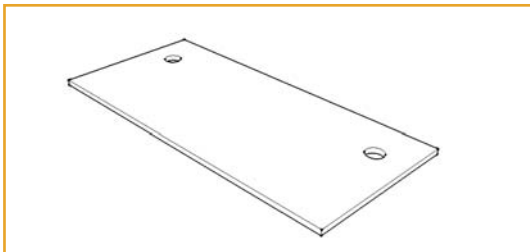

1500mm W x 700mm D x 25mm

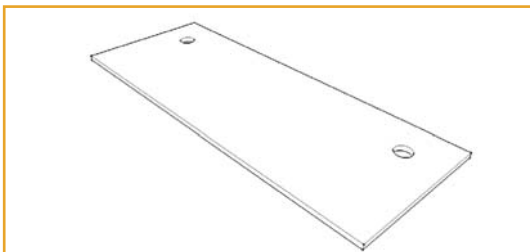

1800mm W x 700mm D x 25mm

TOP COLOURS



Warm White



Beech

SCALLOP TOP



Scallop Top without Cable Entry Holes

1200mm W x 700mm D x 25mm

1500mm W x 700mm D x 25mm

1800mm W x 700mm D x 25mm



Brilliant White ONLY

SCREENS



IS700 B

T Return Screen

690mm W x 20mm T x

350mm H - Screw Fix

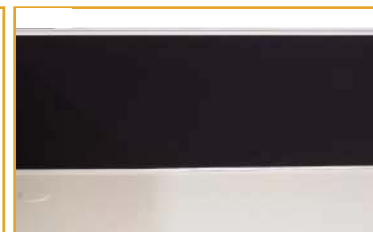

IS1200 B, IS1500 B, IS1800 B

Pinable Black Screen

Top W x 30mm T x 500mm H

Black with White Frame

SCREEN COLOURS



Black





▪ Single Sided, No Screens



▪ Single Sided with Screens



▪ Double Sided with Screens

E1 ENVIRO BOARD

WORKSTATION LEG SYSTEMS

Profile Leg - 60mm + 30mm



PSL W Single Profile Leg
700mm W x 60mm D x 695mm H



PDL W Double Profile Leg
1430mm W x 60mm D x 695mm H

Loop Leg - 60mm + 45mm



LSL W Single Loop Leg
700mm W x 45mm D x 695mm H



LDL W Double Loop Leg
1430mm W x 45mm D x 695mm H



White Powdercoated Steel ONLY

Cable Management Solutions

- Bringing power to the workstation.

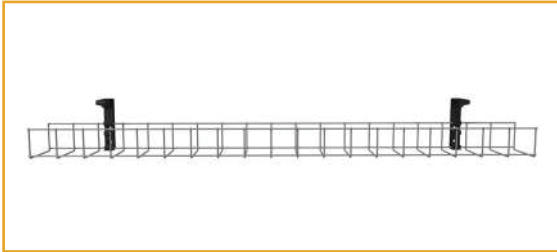

Single Tier Cable Basket

- Under workstation cable tidy.

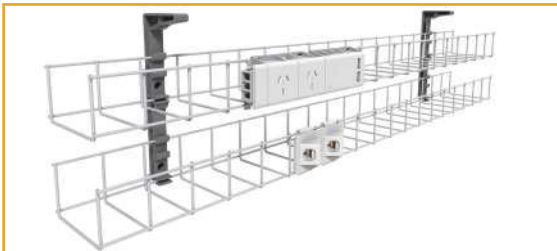

Dual Tier Cable Baskets Kits

- Under desk, for power and data provisions.



Power Rails

- Above desk power and data, clamps onto desk top.



Flip Box

- In desk power and data, suits cut out size 220mm x 80mm. Choose from power only, power and data, or power and USB.



In Desk Module - Use for Hot Desks

- Above desk power, data and double USB, fits in 80mm cable port.



Pop Up Power - Use for Hot Desks

- Above desk power or power and USB. Suits cut out size 200mm x 100mm. Great for single workstations, hot desks and boardrooms.



Power Pole Kits

- Run power and data from ceiling to workstation, or from ceiling to floor. Anodised finish, umbilicals also available.



Boardroom Table Boxes

- Sits in table top, lid closes to obscure power and data points. Suits cut out 295mm x 148mm. Bead blasted natural finish.



Reception and Lounge

The reception area is the bridge between your clients and management. Make the best possible first impression with a fresh, professional looking counter whilst allowing your visitors to wait in comfort with a range of fantastic soft seating designs.

E1 ENVIRO BOARD



WHITE 2000 COUNTER WITH RETURN



Brilliant White ONLY
W2RCW 2200W X 780D X 1045H
W2RW Return 1000W x 600D x 730H



Brilliant White

WHITE 2000 COUNTER



Brilliant White ONLY
 Glass Top Reception Unit
W2RCW 2200W x 780D x 1045H



Brilliant White

MODULAR COUNTER



Modular Reception Counter with 2 Mix & Match Units
 Warm White ONLY
MOD1W Full Height Module 1339W x 872D x 1160H
MOD2W Glass Top Module 1339W x 872D x 935H



Warm White

RC1809



Brilliant White with Black
 Powdercoat Cowl and Kickplate
RC1809 BW 1800W x 800D Workspace



Brilliant White

NEW

BEECH COUNTER WITH RETURN



E1 ENVIRO BOARD

FINISHES
Beech



Available in Beech ONLY
RWRC18 1800W x 762D x 1067H
RWRRCR11 Return 1066W x 610D x 1040H

BEECH COUNTER



Available in Beech ONLY
RWRC15 1500W x 762D x 1067H
RWRC18 1800W x 762D x 1067H

FLOW COUNTER



Available in Beech ONLY
Curved Reception Counter with Glass Feature
NCT1160 2400 x 1600 x 800D





Reception and Lounge Chairs

Mix and Match the Splash Range in different fabric colours to brighten up any contemporary office space.

Chair Dimension Codes
SW = Seat Width
SD = Seat Depth
BH = Back Height
GH = Gas Height Range



SPACE TUB 1

SW	540mm	Compact Tub Chair for Small Spaces in PU Finish
SD	430mm	
BH	370mm	

SPACE EXECUTIVE

SW	480mm	Large Tub Chair with Flared Armrest Feature
SD	470mm	
BH	390mm	

SPLASH CLUB

SW	480mm	Tub Style with Gas Height Adjustment
SD	520mm	
GH	460-590mm	

SPLASH CUBE

SW	460mm	Contemporary Style with Chrome Sled Base
SD	520mm	
BH	330mm	

SPLASH CONE

SW	500mm	Circular Seat with Chrome Cross Base
SD	510mm	
BH	390mm	



SPACE 1

SW	550mm	Soft Black PU Finish, Stylish Frame
SD	515mm	
BH	310mm	

SPACE 2

SW	1110mm	Ideal for Reception or Meeting Areas
SD	515mm	
BH	310mm	

SPACE 3

SW	1670mm	PU Upholstery for Easy Maintenance
SD	515mm	
BH	310mm	

Chair Dimension Codes

SW = Seat Width

SD = Seat Depth

BH = Back Height

GH = Gas Height Range



ENTERPRISE 1



SW 530mm Comfortable
SD 510mm Blue Fabric
BH 320mm Upholstery

ENTERPRISE 2



SW 1010mm Mid Blue Finish
SD 510mm Adds Colour to
BH 320mm Any Space

ENTERPRISE 3



SW 1530mm Generous Size
SD 510mm with Chrome
BH 320mm Sled Base

VENUS 1



SW 630mm Classic Design,
SD 500mm Distinctive
BH 400mm Button Finish

VENUS 2



SW 1120mm Pair with
SD 500mm Matching
BH 400mm Ottoman

VENUS 3



SW 1770mm Ideal for
SD 500mm Reception or
BH 400mm Meeting Areas

VENUS OTTOMAN



SW 1030mm Use as an
SD 540mm Ottoman or
H 410mm Foot Stool

E1 ENVIRO BOARD

RAPID 50



Rapid 50 Coffee Table
White 50mm Frame
R50CT 1200W x 600D x 450H

BLACK GLASS



Black Glass Coffee Table
AGT66 600W x 600D x 450H
AGT126 1200W x 600D x 450H

E1 ENVIRO BOARD

BUDGET



Budget Coffee Table
Ironstone Base
CT96 900W x 600D x 450H

E1 ENVIRO BOARD

CHROME BASE



Round 600mm DIA. Coffee
Table with Chrome Base
CCT6 600 DIA. x 425H



CREATE YOUR WORKSTATION ENVIRONMENT

We can help with consultation and planning to providing drawings or 3D rendered images of your design.



ASK FOR A QUOTE & FLOOR PLAN



Rapid Screen Workstation System

Off the shelf, slimline workstation system with multiple configuration options. Slimline screen system with blue or grey screens in 1250mm or 1650mm heights. Choose between blue or grey fabric screens with warm white or beech desk tops. Select from different leg styles and colours to match your office workspace.



SCREEN COLOURS
Grey
Blue

TOP FINISHES
Beech
Warm White

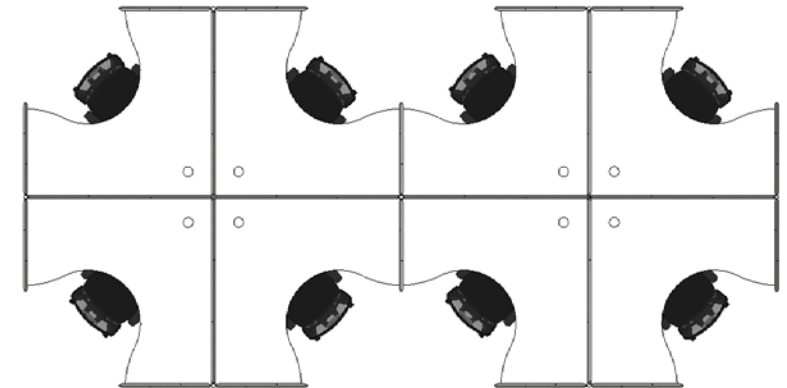
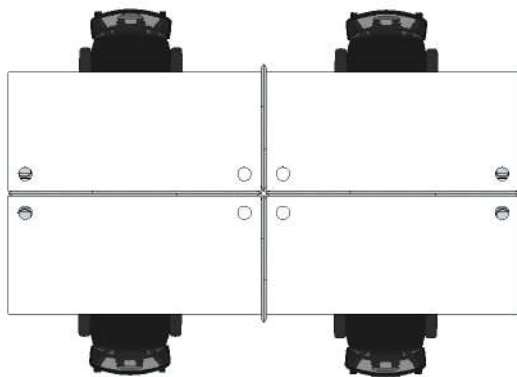

MAXIMISE SPACE WITH OPEN WORKSTATIONS

SPREAD OUT WITH A 3 WAY 120° WORKSTATION

4 WAY WORKSTATION FOR MAXIMUM DESK SPACE

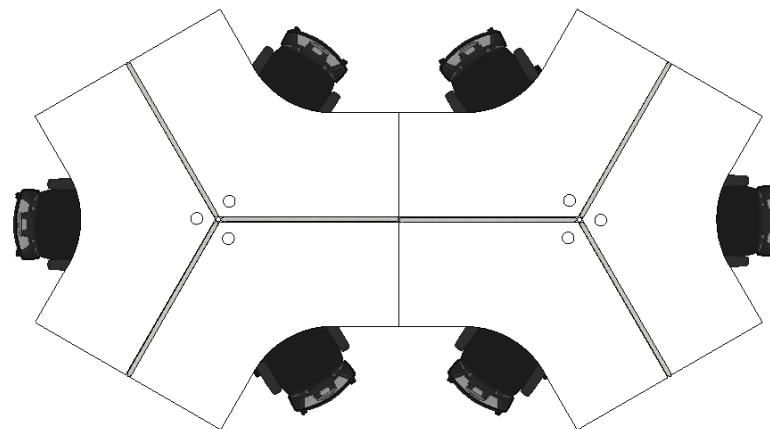

WORKSTATION TOP SIZES



WORKSTATION TOP COLOURS

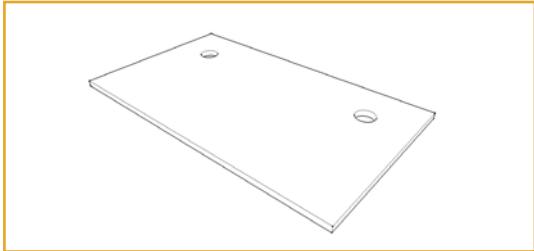

1200mm W x 700mm D x 25mm T

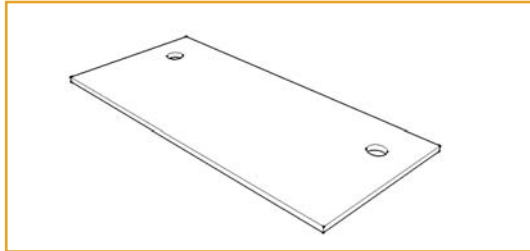

1500mm W x 700mm D x 25mm T

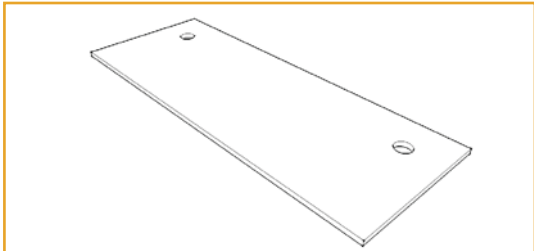

1800mm W x 700mm D x 25mm T

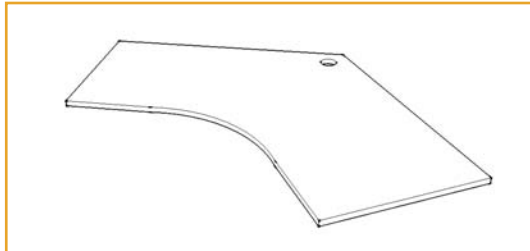

1200mm x 1200mm W x 700mm D x 25mm T

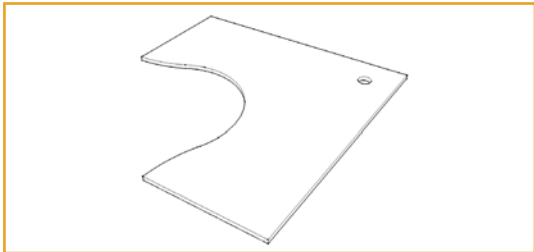

1500mm x 1500mm W x 700mm D x 25mm T

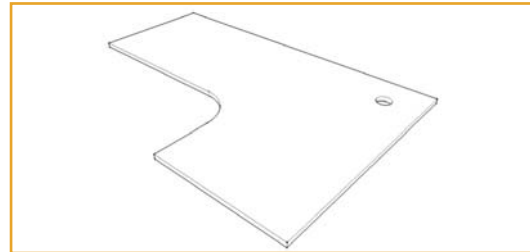

1800mm x 1200mm W x 700mm D x 25mm T

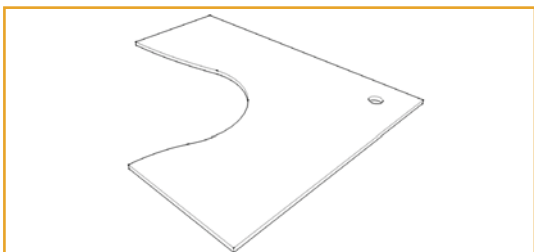

1800mm x 1500mm W x 700mm D x 25mm T

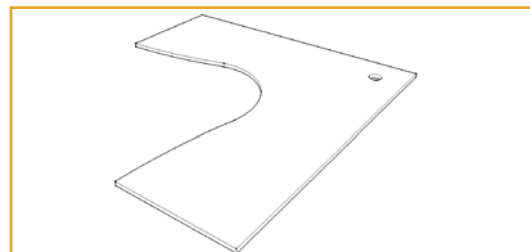

1800mm x 1800mm W x 700mm D x 25mm T

SCREEN HEIGHTS

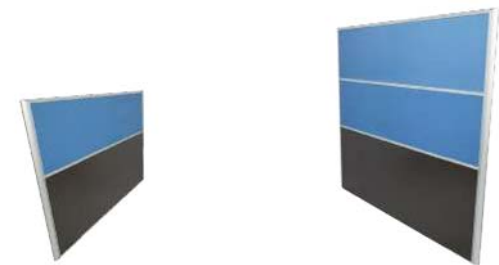

1250mm HIGH SCREEN 1650mm HIGH SCREEN

750mm, 1200mm, 1500mm or 1800mm W
x 1250mm or 1650mm H x 30mm T

SCREEN COLOURS



WORKSTATION LEG SYSTEMS

SPAN LEGS

705mm H x 560mm D

Adjustable feet and cable management in leg

ADJUSTABLE LEG

650 - 800mm H

Tapered DIA. 65 to 50mm

C LEG

705mm H x 550mm D

Adjustable feet

DC-60 POLE LEGS

60mm DIA. x 705mm H Round

Leg with Adjustable Foot



SPLEG
White



SPLEG
Black



SPLEG
Precious Silver



AD LEG
White or Precious Silver

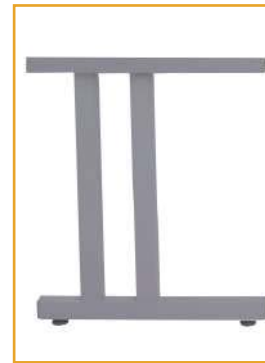

C LEG
Precious Silver



DC-60 LEG
Chrome, Black or White

NEW

SCREEN ACCESSORIES



900mm Shelf
Shown with Brackets



4 Space Document Divider



Document Tray

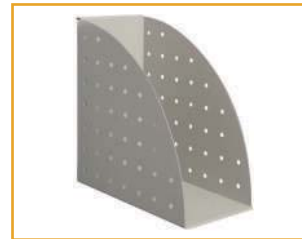

File Holder



JOINING POLES

1250mm or 1650mm High
Link screens at 90, 180 or
120 degrees. Use in corners
or to join return screens.



Double Pen Holder



Triple Pen Holder



Free Standing Foot



Wall Starter



WHITE & SILVER CLEG DESK



1200 x 700 1500 x 700 1800 x 700
 Desk & Return 1800 x 700 / 1100 x 600

- Perforated Metal or Melamine Modesty Panels
- Image above: White Top, White Melamine Modesty Panel and Silver C Legs.

WHITE & SILVER CORNER WORKSTATION



1500 x 1500 x 700 1800 x 1200 x 700
 1800 x 1500 x 700 1800 x 1800 x 700

- Perforated Metal or Melamine Modesty Panels
- Image above: White Top, Silver Metal Modesty Panel and Silver Span Legs.

WHITE & SILVER SPAN DESK WITH RETURN



Desk & Return 1800 x 700 / 1100 x 600

- Perforated Metal or Melamine Modesty Panels
- Image above: White Top with Return, Silver Melamine Modesty Panels and Silver Span Legs.

WHITE & WHITE SPAN DESK



1200 x 700 1500 x 700 1800 x 700
 Desk & Return 1800 x 700 / 1100 x 600

- Perforated Metal or Melamine Modesty Panels
- Image above: White Top, White Metal Modesty Panel and White Span Legs.

WHITE & BLACK CORNER WORKSTATION



1500 x 1500 x 700 1800 x 1200 x 700
 1800 x 1500 x 700 1800 x 1800 x 700

- Perforated Metal or Melamine Modesty Panels
- Image above: White Top, White Melamine Modesty Panel and Black Span Legs.

WHITE & WHITE SPAN DESK WITH RETURN



FRAME FINISHES
Silver
White
Black

Desk & Return 1800 x 700 / 1100 x 600

- Perforated Metal or Melamine Modesty Panels
- Image above: White Top with Return, White Metal Modesty Panel and White Span Legs.

WORKSTATION TOP SIZES

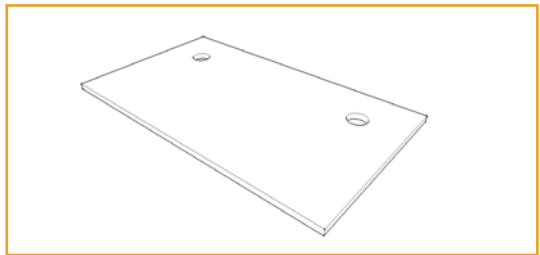

1200mm W x 700mm D x 25mm T

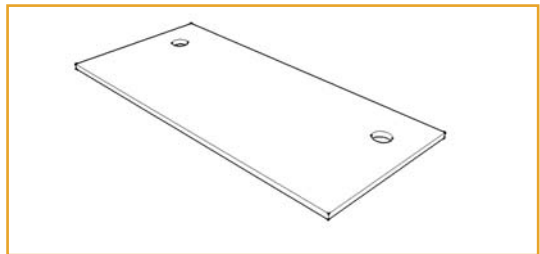

1500mm W x 700mm D x 25mm T

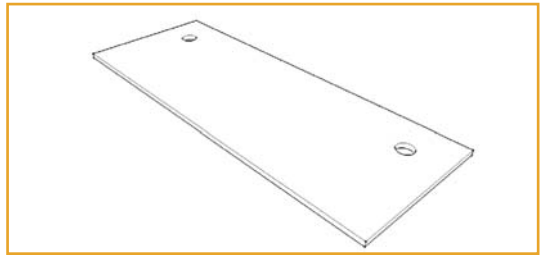

1800mm W x 700mm D x 25mm T

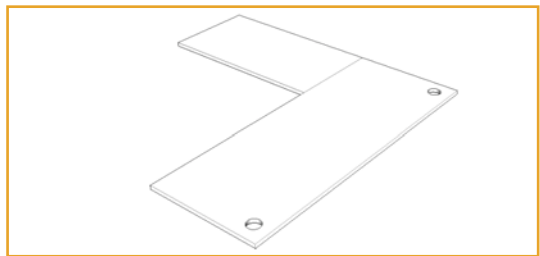

1800mm W x 700mm D / 1100mm W x 600mm D

E1 ENVIRO BOARD

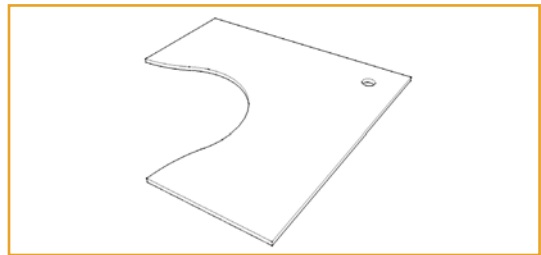

1500mm x 1500mm W x 700mm D x 25mm T

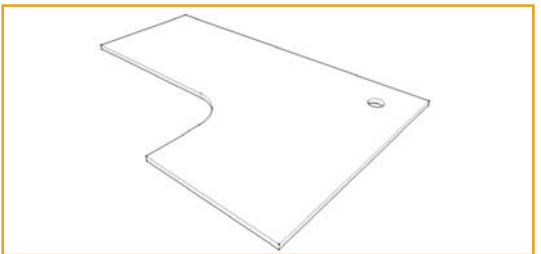

1800mm x 1200mm W x 700mm D x 25mm T

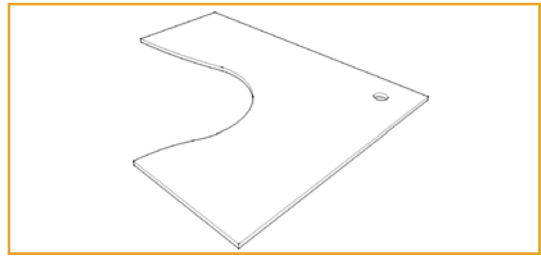

1800mm x 1500mm W x 700mm D x 25mm T

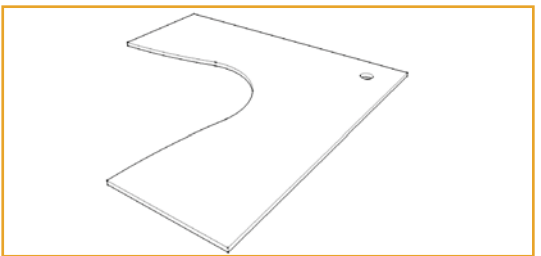

1800mm x 1800mm W x 700mm D x 25mm T

TOP FINISHES

- Beech
- Warm White

MODESTY FINISHES

- White Perforated Metal
- Black Perforated Metal
- Silver Perforated Metal
- Beech Melamine
- Warm White Melamine



Rapid Span Workstation System

Create a modern, clean office space with the Rapid Span white workstation and matching furniture range.



MODESTY PANEL STYLES



Metal Modesty Panel with Perforated Detail



Melamine Modesty Panel to match Desk Top

WORKSTATION LEG SYSTEMS

SPAN LEGS - SPLEG

705mm H x 560mm D

Adjustable feet and cable tidy in leg



C LEG

705mm H x

550mm D

Adjustable feet

WORKSTATION EXAMPLES



- Warm White Top, White Perforated Metal Modesty & White Span Legs



- Warm White Top, Black Perforated Metal Modesty & Black Span Legs

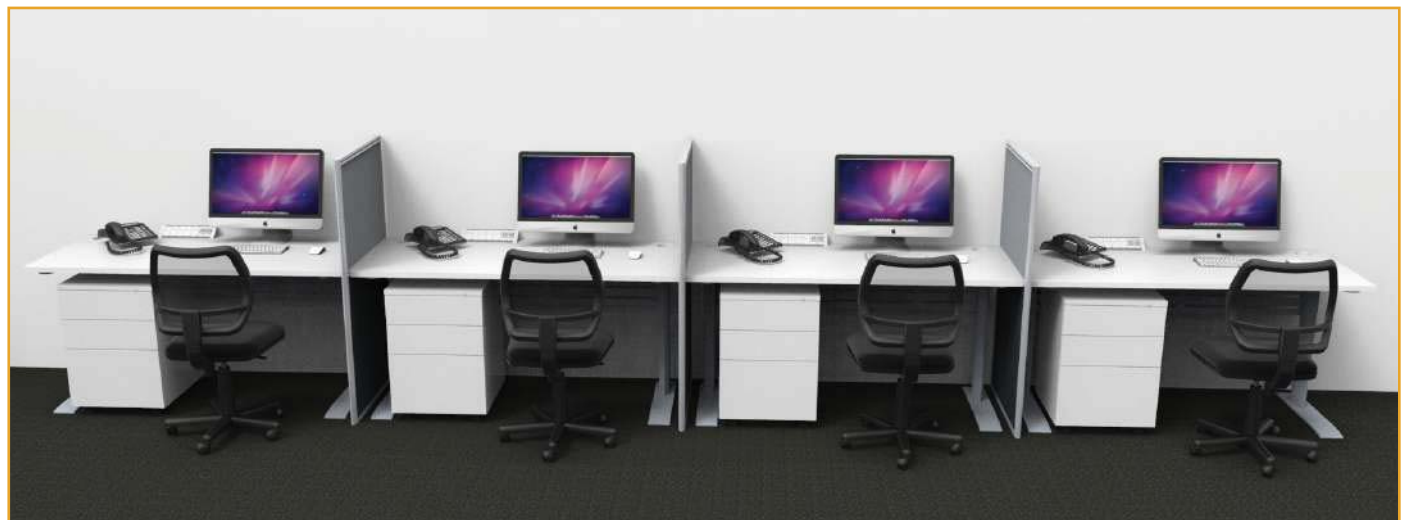

- Warm White Tops, Grey 1250H Screens, Perforated Metal Modesty and Span Legs in Silver



Rapid Span Furniture

Matching furniture and storage range to compliment any Rapid Span white desk or workstation.



CREDENZA



Includes 2 Adjustable Shelves
SPC12 1200W x 450D x 730H
SPC18 1800W x 450D x 730H

HUTCH



Includes Adjustable Shelves
SPH12 1200W x 315D x 1070H
SPH18 1800W x 315D x 1070H

SILVER FRAME MEETING



Rectangular Shaped Top with White Top and Silver Frame
RST189W 1800W x 900D x 730H
RST1875W 1800W x 750D x 730H

MOBILE PEDESTAL



447W x 465D x 690H
 Lockable Mobile Pedestal
SPMP3 3 Drawers

CUPBOARD



Lockable, 1 Fixed, 3 Adjustable Shelves
SP2FD18 900W x 450D x 1800H

BOOKCASE



Includes Adjustable Shelves
SPBC12 900W x 315D x 1200H
SPBC18 900W x 315D x 1800H

TYPHOON BOARDROOM



Typhoon Boardroom Table, Black and Chrome Frame
TTR189 1800 x 900 x 750H Twin Post, Single Stage Frame
TTR2412 2400 x 1200 x 750H Twin Post, Single Stage Frame
TTR3212 3200 x 1200 x 750H Twin Post, Dual Stage Frame

FINISHES

Warm White

NEW



4 STAR ROUND



4 Star Silver Round Base
RSRT6 600mm DIA. Top
RSRT9 900mm DIA. Top
RSRT12 1200mm DIA. Top

TYPHOON ROUND



NEW

Typhoon 4 Star Base Round Table
 Black and Chrome Base with White Top
TTR900 900mm DIA. Top
TTR1200 1200mm DIA. Top

BEECH & SILVER CLEG DESK



1200 x 700 1500 x 700 1800 x 700
 Desk & Return 1800 x 700 / 1100 x 600

- Perforated Metal or Melamine Modesty Panels
- Image above: Beech Top, Silver Metal Modesty Panel and Silver C Legs.

BEECH & WHITE CORNER WORKSTATION



1500 X 1500 X 700 1800 X 1200 X 700
 1800 X 1500 X 700 1800 X 1800 X 700

- Perforated Metal or Melamine Modesty Panels
- Image above: Beech Top, White Metal Modesty Panel and White Span Legs.

BEECH & SILVER SPAN DESK WITH RETURN

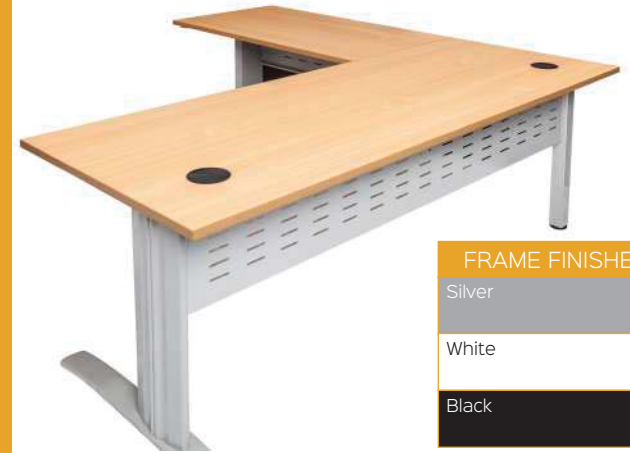

FRAME FINISHES
Silver
White
Black

Desk & Return 1800 x 700 / 1100 x 600

- Perforated Metal or Melamine Modesty Panels
- Image above: Beech with Return, Silver Metal Modesty Panels and Silver Span Legs.

BEECH & BLACK SPAN DESK



1200 x 700 1500 x 700 1800 x 700
 Desk & Return 1800 x 700 / 1100 x 600

- Perforated Metal or Melamine Modesty Panels
- Image above: Beech Top, Black Metal Modesty Panel and Black Span Legs.

BEECH & BLACK CORNER WORKSTATION



1500 X 1500 X 700 1800 X 1200 X 700
 1800 X 1500 X 700 1800 X 1800 X 700

- Perforated Metal or Melamine Modesty Panels
- Image above: Beech Top, Black Metal Modesty Panel and Black Span Legs.

BEECH & BLACK SPAN DESK WITH RETURN



Desk & Return 1800 x 700 / 1100 x 600

- Perforated Metal or Melamine Modesty Panels
- Image above: Beech Top with Return, Black Metal Modesty Panel and Black Span Legs.

WORKSTATION TOP SIZES

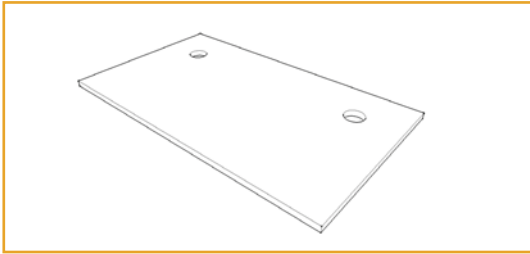

1200mm W x 700mm D x 25mm T

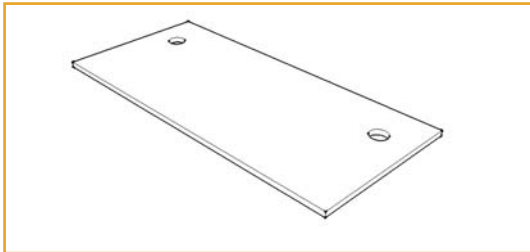

1500mm W x 700mm D x 25mm T

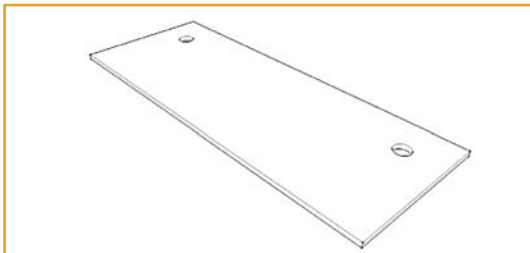

1800mm W x 700mm D x 25mm T

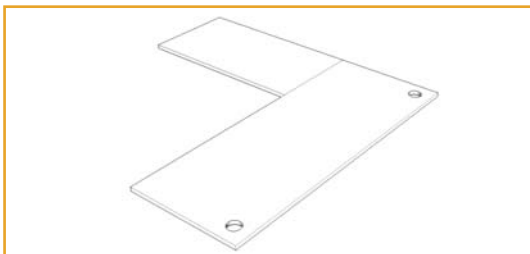

1800mm W x 700mm D / 1100mm W x 600mm D

E1 ENVIRO BOARD

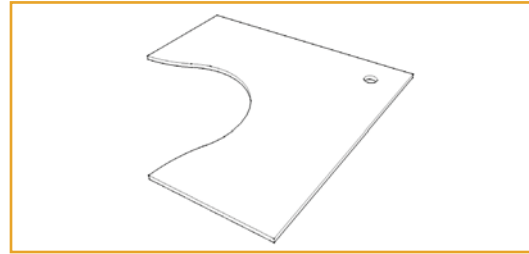

1500mm x 1500mm W x 700mm D x 25mm T

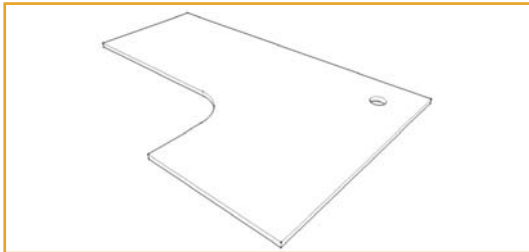

1800mm x 1200mm W x 700mm D x 25mm T

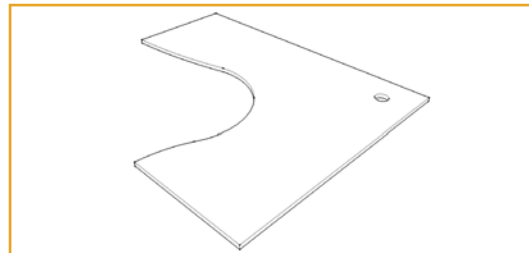

1800mm x 1500mm W x 700mm D x 25mm T

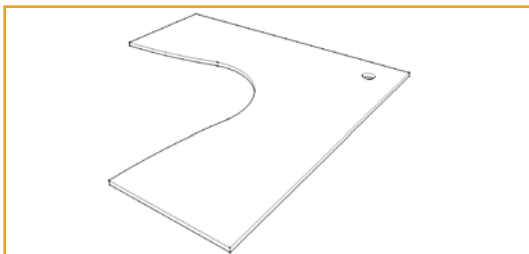

1800mm x 1800mm W x 700mm D x 25mm T

TOP FINISHES

Beech

Warm White

MODESTY FINISHES

White Perforated Metal

Black Perforated Metal

Silver Perforated Metal

Beech Melamine

Warm White Melamine



Rapid Span Workstation System

Create a modern, clean office space with the Rapid Span beech workstation and matching furniture range.



MODESTY PANEL STYLES



Metal Modesty Panel with Perforated Detail



Melamine Modesty Panel to match Desk Top

WORKSTATION LEG SYSTEMS

SPAN LEGS - SPLEG

705mm H x 560mm D

Adjustable feet and cable tidy in leg



C LEG

705mm H x
550mm D
Adjustable feet

WORKSTATION EXAMPLES



■ Beech Top, Silver Perforated Metal Modesty & Silver Span Legs



■ Beech Top, Black Perforated Metal Modesty & Black Span Legs



■ Beech Tops, Grey 1250H Screens, Perforated Metal Modesty and Span Legs in Silver



Rapid Span Furniture

Matching furniture and storage range to compliment any Rapid Span beech desk or workstation.



CREDENZA



Includes Adjustable Shelves
SPC12 1200W x 450D x 730H
SPC18 1800W x 450D x 730H

HUTCH



Includes Adjustable Shelves
SPH12 1200W x 315D x 1070H
SPH18 1800W x 315D x 1070H

SILVER FRAME MEETING



Rectangular Shaped Top with Silver Frame and Beech Top
RST189B 1800 x 900 x 730H
RST1875B 1800 x 750 x 730H

MOBILE PEDESTAL



447W x 465D x 690H
 Lockable Mobile Pedestal
SPMP3 3 Drawers

CUPBOARD



Lockable, 1 Fixed, 3 Adjustable Shelves
SP2FD18 900W x 450D x 1800H

BOOKCASE



Includes Adjustable Shelves
SPBC12 900W x 315D x 1200H
SPBC18 900W x 315D x 1800H

TYPHOON BOARDROOM



Typhoon Boardroom Table, Black and Chrome Frame
TTR189 1800 x 900 x 750H Twin Post, Single Stage Frame
TTR2412 2400 x 1200 x 750H Twin Post, Single Stage Frame
TTR3212 3200 x 1200 x 750H Twin Post, Dual Stage Frame

FINISHES

Beech

NEW



4 STAR ROUND



4 Star Silver Round Base
RSRT6 600mm DIA. Top
RSRT9 900mm DIA. Top
RSRT12 1200mm DIA. Top

TYPHOON ROUND



NEW

Typhoon 4 Star Base Round Table
 Black and Chrome Base with Beech Top
TTR900 900mm DIA. Top
TTR1200 1200mm DIA. Top

Tables

Extensive range of tables including boardroom, lounge, breakout, meeting, coffee tables and educational applications.

STEEL FRAME TABLE



Steel Frame Table
40mm Black Legs with Adjustable Feet
SFT126 1200W x 600D x 730H SFT1575 1500W x 750D x 730H
SFT1875 1800W x 750D x 730H SFT189 1800W x 900D x 730H

FOLDING TABLE



25mm Melamine Top with 30mm Black Frame
FFT1575 1500W x 750D x 730H
FFT1875 1800W x 750D x 730H
FFT189 1800W x 900D x 730H

TOP FINISHES

- Beech
- Warm White
- Cherry
- Grey

FLIP TOP TABLE



Precious Silver Frame with Locking Castors
Use with Table Links to Connect Multiple
FTT1575 1500W x 750D x 730H
FTT1875 1800W x 750D x 730H

TYPHOON FLIP TOP



Typhoon Flip Top Table
Black and Chrome Finish
TFT1575 1500W x 750D x 750H
TFT1875 1800W x 750D x 750H

NEW

POLY FOLDING



Poly Folding Table
White Plastic Top and Silver Frame
PT1875 1800 x 750 x 730H
PT209 2000 x 900 x 730H

RAPID EDGE FOLDING



Rapid Edge Folding Boardroom Table, 18mm Thick Top,
Rubber Edging, Black and Chrome Frame, Locking Castors
Driftwood or White Top, Includes Pair of Table Links
FBT2410 2400 x 1000 x 743H

NEW

FINISHES

- Driftwood
- Brilliant White



CHROME BASE ROUND



Chrome Base Round Table
CBT6 600mm DIA. Top
CBT9 900mm DIA. Top
CBT12 1200mm DIA. Top

4 STAR ROUND



4 Star Silver Round Base
RSRT6 600mm DIA. Top
RSRT9 900mm DIA. Top
RSRT12 1200mm DIA. Top

2.4M BOARDROOM



Rectangular Shaped Top with Ironstone Base
 Available with White, Cherry or Appletree Top
CBT2412 2400 x 1200 x 730H

NEW

IRONSTONE ROUND



Ironstone Base Round Table
 Available with White, Cherry or Beech Top
CRM9 900mm DIA. Top
CRM12 1200mm DIA. Top

TYPHOON 4 STAR



Typhoon 4 Star Base Round Table
 Black and Chrome Base
TTR900 900mm DIA. Top
TTR1200 1200mm DIA. Top

NEW

3.2M BOARDROOM



Rectangular Shaped 2 Piece Top
 Available with Cherry, Beech or White Top
CBT3212 3200 x 1200 x 730H

NEW



TYPHOON BOARDROOM



NEW

Typhoon Boardroom Table, Black and Chrome Frame

TTR189 1800 x 900 x 750H Available with White, Beech, Cherry or Grey Top
TTR2412 2400 x 1200 x 750H Available with White, Beech, Cherry or Appletree Top
TTR3212 3200 x 1200 x 750H Available with White, Cherry or Beech Top

RAPID AIR BOARDROOM



NEW

Rapid Air Boardroom Table, Polished Aluminium Legs with Black Powdercoated Frame
RAB2412 2400 x 1200 x 730H Available with White, Beech, Cherry or Appletree Top
RAB3212 3200 x 1200 x 730H Available with White, Cherry or Beech Top



High Tables

High tables for drafting, perfect for hospitality or creating breakout areas.

HIGH BAR TABLE



NEW

High Bar Rectangular Table - 1050mm High
Black Powdercoated Frame, Adjustable Levelling Feet
HBT189 1800 x 900 x 1050H Available with White, Beech, Cherry or Grey Top

TOP FINISHES
Beech
Warm White
Cherry
Grey

DRY BAR



Dry Bar Round Table - 1070mm High
CDBT6 600mm DIA. Round Top x 1070H
Available with White, Beech or Cherry Top

DRAFTING TABLE



900mm High Drafting Table in all Top Colours
9SFT1575 1500 x 750 x 900H
9SFT189 1800 x 900 x 900H



Manual Height Adjustable Desk

Standalone manual height adjustable workstations, to adjust desk top height to suit user from sitting to standing position.

Low geared mechanism for ease of adjustment.

Universal crank handle, fold handle away when not in use.

FINISHES
Warm White

MANUAL HEIGHT ADJUSTABLE

NEW



Manually Height Adjustable Desk
 Desk Height from 715mm to 1015 mm
 White Powdercoated Frame
 Maximum Load 100kg
TMA127 1200 W x 700 D
TMA157 1500 W x 700 D
TMA187 1800 W x 700 D
 Available with White or Beech Top



Rapid Surge Adjustable Desk

Standalone gas lift operated height adjustable desks, to adjust desk top height to suit user from sitting to standing position.

Improve posture, back pain and risk of weight gain by simply adjusting your work top height.

FINISHES
White

RAPID SURGE HEIGHT ADJUSTABLE

NEW



Gas Lift Operated Height Adjustable Desk
 Desk Height from 750mm to 1100mm
 White Powdercoated Frame
 Maximum Load 22kg
 Control Levers Each Side
 12 Different Height Settings
 Worksurface Size:
 1190 W x 590 D
 Available with White Top and Frame



Rapid Span Electric Desks and Workstations

For many people a standard 730mm high desk height will not allow them to work comfortably and efficiently. When sharing workstations, a height adjustable workstation will be a valuable work tool to suit a range of users.

STRAIGHT DESK



PRODUCT CODES

- SE 127 1200 W x 700 D
- SE 157 1500 W x 700 D
- SE 187 1800 W x 700 D

- SE 15157 1500 x 1500 x 700 D
- SE 18127 1800 x 1200 x 700 D
- SE 18157 1800 x 1500 x 700 D
- SE 18187 1800 x 1800 x 700 D

- Desk height 685 - 1205mm
- Maximum load 100kg
- Modesty panel for rigidity
- Stiffening rail for tops
- 31mm per second speed

TOP FINISHES
Beech
Warm White

FRAME FINISHES
Silver
White

CORNER WORKSTATION



COMPONENTS



SS-SPLEG

Frame in White or Precious Silver
Modesty Panel Optional Extra



SS-SPCNR

Corner Pole



SS-PSC

Optional Pre Set Control
3 Height settings for up to 3 users

Paramount Height Adjustable Workstation System

The Paramount system exceeds expectations with stability, rigidity, strength and style.

The system provides full height adjustment from 630mm H to 1252mm H, and includes full cable management with an adaptable built in cable tray which also allows the option for power and data as an added extra.

SINGLE HEIGHT ADJUSTABLE



NEW

Single Height Adjustable Workstation
 Desk Height from 630 to 1252 mm
 White Frame and Top, Maximum Load 100 kg
REP1P187
 1800 W x 750 D

SINGLE WITH SCREEN HEIGHT ADJUSTABLE



NEW

Single Height Adjustable Workstation with Screen
 Desk Height from 630 to 1252 mm, Black Screen 1695mm W x 805mm H
 White Frame and Top, Maximum Load 100 kg
REPWS1P187
 1800 W x 750 D

BACK TO BACK HEIGHT ADJUSTABLE



NEW

Back to Back Height Adjustable Workstation
 Desk Height from 630 to 1252 mm
 White Frame and Top, Black Screen 1695mm W x 805mm H
 Maximum Load 100 kg
REPWS2P187
 1800 W x 750 D

E1 ENVIRO BOARD





Rapid Riser

Height adjustable solution for on top of existing open or corner workstation. Generous size work surface, gas spring for smooth height adjustment and control levers each side. Built in tablet or phone holder and includes cable tie for any leads or cables. Grommet hole for monitor arm mounting.

RAPID RISER SMALL



Rapid Riser Small - White
RR1 W 680 W x 590 D

RAPID RISER SMALL



Rapid Riser Small - Black
RR1 B 680 W x 590 D

RAPID RISER MEDIUM



Rapid Riser Medium - White
RR2 W 890 W x 590 D

RAPID RISER MEDIUM



Rapid Riser Medium - Black
RR2 B 890 W x 590 D



Monitor Arms

Attaches to your existing or new desk and allows movement of monitor to best suit users height and eyeline.

- 5kg capacity per arm
- Fits 10-27" monitors
- Vesa holes 100 x 100 or 75 x 75
- Audio, microphone and USD 3.0 ports

SINGLE MONITOR ARM



Single Monitor Arm
SMARM 75-480mm Height Range



REVOLVE SINGLE ARM



Revolve Pole Mounted Single Arm
RMA1 BL 260-360mm Height Range
392mm Overall Height, Cable Management within Pole



REVOLVE QUAD ARM



Revolve Pole Mounted Quad Arm
RMA4 BL 260-360mm Height Range
392mm Overall Height, Cable Management within Pole



DUAL MONITOR ARM



Dual Monitor Arm
DMARM 75-480mm Height Range



REVOLVE DUAL ARM



Revolve Pole Mounted Dual Arm
RMA2 BL 260-360mm Height Range
392mm Overall Height, Cable Management within Pole



ELEVATE ARM



Elevate Arm
ELEVATE ARM 180-480mm Height Range
Also Available in Black, Gas Operated





The Rapid Vibe Range

All White or Grey finishes for a clean, fresh look, 25mm thick tops on all desks and workstations. Locking storage and metal runners in all drawers.

E1 ENVIRO BOARD

FINISHES
Warm White
Grey

DESK



CDK1575 1500W x 750D x 730H
CDK189 1800W x 900D x 730H

CORNER WORKSTATION



CWS1818 1800W x 1800W x 600D x 730H

DESK HOB



CHOB18N 1800W x 300D x 450H

HOME OFFICE DESK



CDK126 1200W x 600D x 730H
HDKP1D Single Drawer Extra

LAPTOP DESK



CDK96 900W x 600D x 730H

MOBILE PEDESTAL



447W x 465D x 690H
Lockable Mobile Pedestal
SPMP3 3 Drawers

FIXED PEDESTAL



Optional Extra for Desks
Lockable Fixed Pedestal
CDKP3D 3 Drawers

DESK RETURN



Add to Straight Desks
CR6 900W x 600D



E1 ENVIRO BOARD

CREDENZA



Includes 2 Adjustable Shelves
SPC12 1200W x 450D x 730H
SPC18 1800W x 450D x 730H

HUTCH



Includes Adjustable Shelves
SPH12 1200W x 315D x 1070H
SPH18 1800W x 315D x 1070H

CUPBOARD



Lockable, 1 Fixed, 3 Adjustable Shelves
SP2FD18 900W x 450D x 1800H

BOOKCASE



Includes Adjustable Shelves
SPBC12 900W x 315D x 1200H
SPBC18 900W x 315D x 1800H





The Rapid Worker Range

Sturdy, traditional, all melamine construction, 25mm thick tops on all desks and workstations. Locking storage and metal runners in all drawers.



FINISHES	
Beech	Ironstone
Cherry	Ironstone

DESK



CDK96	900W x 600D x 730H	
CDK126	1200W x 600D x 730H	
CDK1575	1500W x 750D x 730H	
CDK1875	1800W x 750D x 730H	* Drawers Not Included
CDK189	1800W x 900D x 730H	* Drawers Not Included

CORNER WORKSTATION



1200 x 1200 x 600D	1200 x 1500 x 600D	
1200 x 1800 x 600D	1200 x 2100 x 600D	
1500 x 1500 x 600D	1800 x 1500 x 600D	
1800 x 1800 x 600D	1800 x 1800 x 750D	* Drawers Not Included
2100 x 1500 x 600D	2100 x 1800 x 600D	* Drawers Not Included
2100 x 2100 x 600D		

DESK HOB



CHOB15N	1500W x 300D x 450H
CHOB18N	1800W x 300D x 450H

DESK RETURN



CR45	900W x 450D	
CR6	900W x 600D	* Drawers Not Included
CR12	1200W x 600D	* Drawers Not Included

FIXED PEDESTAL



CDKP1D1F	2 Drawers
CDKP3D	3 Drawers
CRP3D	Return

MOBILE PEDESTAL



447W x 465D x 690H	
CMP2F	2 Drawers
CMP2D1F	2 Drawers, 1 File
CMP4D	4 Drawers

MOBILE PEDESTAL



447W x 465D x 690H	
Ironstone ONLY	
Lockable Mobile Pedestal	
CMP2D1F-I	2 Drawers, 1 File

CREDENZA



CMZ1245	1200W x 730D x 450H
CMZ1545	1500W x 730D x 450H
CMZ1845	1800W x 730D x 450H

DRAWER



Ironstone ONLY
No Lock
HDKPID 1 Drawer



E1 ENVIRO BOARD

FINISHES	
Beech	Ironstone
Cherry	Ironstone



HUTCH

- CH12 1200W x 315D x 1070H Includes 4 Shelves
- CH15 1500W x 315D x 1070H Includes 4 Shelves
- CH18 1800W x 315D x 1070H Includes 6 Shelves



PIGEON HOLE UNIT

- 20 Hole Unit - Includes 16 Shelves
- PH20 1040W x 380D x 1040H



UTILITY TROLLEY

- Ironstone ONLY
- TR3 800W x 600D x 900H



CUPBOARD

- Lockable, includes 4 Shelves
- CSC2FD 900W x 450D x 1800H



LOCKABLE WALL UNIT

- Lockable - Includes 4 Shelves
- CSC2HD 900W x 450D x 1800H



BOOKCASE

- CBC9 900W x 315D x 900H
- CBC12 900W x 315D x 1200H
- CBC18 900W x 315D x 1800H



FILING CABINET

- Lockable
- C3FC 465W x 600D x 990H
- C4FC 465W x 600D x 1300H



The Rapid Manager Range

Classic dark wood style,
Melamine or metal base desk options.
Rounded corners on tops and full height modesty panel.



OPEN WORKSTATION



Appletree / Ironstone Desk
Optional Extra: VR6 Return 900W x 600D
Lockable Drawers Extra
VDK1575 1500W x 750D x 730H
VDK1875 1800W x 750D x 730H

CORNER WORKSTATION



Appletree / Ironstone Corner Workstation
One Piece Top with Melamine Base
VCW186 1800 x 1800 x 600D x 730H

FIXED PEDESTAL



465W x 447D x 454H
Use with Ironstone Base
VDKP1D1F 1 Drawer, 1 File
VDKP3D 3 Drawers

OPEN WORKSTATION

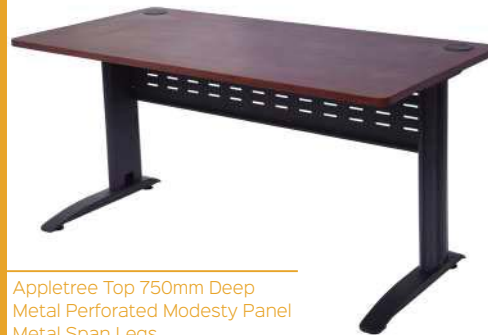

Appletree Top 750mm Deep
Metal Perforated Modesty Panel
Metal Span Legs
VDKMB1575 1500W x 750D x 730H
VDKMB1875 1800W x 750D x 730H

METAL BASE CORNER



Appletree One Piece Top 700mm Deep
One Piece Top with Black Metal Base
VCWMB186 1800 x 1800 x 600D x 730H



FINISHES
 Appletree
 Ironstone

HUTCH



Appletree / Ironstone Hutch Storage
 Use with Melamine Base Desks
VH18 1800W x 380D x 1050H

RAPID AIR BOARDROOM



Rapid Air Boardroom Table
RAB2412 2400 x 1200 x 730H Available with Appletree Top
 Also available with Melamine Base

TYPHOON ROUND



Typhoon 4 Star Base Round Table
 Black and Chrome Base
 900mm DIA. Top
 1200mm DIA. Top

MOBILE PEDESTAL



447W x 465D 690H
 Lockable Mobile Pedestal
VMP2D1F 2 Drawers, 1 File

CUPBOARD



Lockable, includes 4 Shelves
VSC2FD 900W x 450D x 1800H

BOOKCASE



Appletree Shelves with Ironstone Sides
 Includes 4 Adjustable Shelves
VBC18 900W x 315D x 1800H

FILING CABINET



Lockable
 4 Drawers of Storage Space
V4FC 465W x 600D x 1300H

HOB



Reception Hob ONLY
 Add to Desk to create Reception Counter
VHOB18 Reception Hob

CREDENZA



Lockable Credenza
VCZ1245 1200W x 730D x 450H
VCZ1845 1800W x 730D x 450H



NEW MESH CHAIR SERIES



FABRICS

Black



LUMINOUS

SW 480mm
SD 545mm
GH 420-510mm
High Back Mesh Executive Chair with Synchro Mechanism, Adjustable Arms and Stylish White Frame

165KG WEIGHT RATING

FABRICS

Black



ERGO



SW 520mm
SD 490mm
GH 450-540mm
Fully Ergonomic with Seat Slide and Ratchet Back For Heavy Duty Use

HARTLEY TASK



SW 500mm
SD 480mm
GH 440-520mm
Synchro Mech with Tension Control and Adjustable Arms

KAL

FABRICS

Black



SW 500mm
SD 510mm
GH 430-520mm
High Back with Lumbar Support, Synchro Mech and Adjustable Arms

HARTLEY VISITOR



SW 510mm
SD 480mm
BH 485mm
Black Cantilever Frame Adjustable Arms Mesh Visitor Chair

Chair Dimension Codes

SW = Seat Width
SD = Seat Depth
BH = Back Height
GH = Gas Height Range

FABRICS

Black



ZOOM

ZOOM TABLET for use with Zoom Chair ONLY.



SW 460mm
SD 490mm
BH 330mm
Mesh Back, Foldable Training and Conference Chair, with Optional Extra Foldable Tablet Arm.

EM300



FABRICS
Black Fabric
Black PU



SW 490mm Fully Ergonomic, Black
SD 440mm Fabric or Black PU, Chrome
GH 460-590mm Base Optional Extra

AM300



FABRICS
Black



SW 525mm High Back, Infinite Lock
SD 510mm Tilt, Adjustable Arms and
GH 465-530mm Polished Aluminium Base

AM200



FABRICS
Black



SW 520mm Medium Back, Infinite Lock
SD 500mm Tilt, Adjustable Arms and
GH 420-520mm Polished Aluminium Base

AM100



FABRICS
Black



SW 470mm Fully Ergonomic with
SD 490mm Black Mesh Back
GH 460-550mm Arms as Standard

RIVER



FABRICS
Black



SW 480mm Synchro Back and Seat Tilt Adjustment,
SD 470mm Ratchet Back, Adjustable Arms
GH 460-570mm Available as Optional Extra

DAM



FABRICS
Black



SW 520mm AFRDI Level 6, Fully Ergonomic with
SD 470mm Tension Control, Heavy Duty Mesh,
GH 520-600mm Ratchet Back, Spider Base and Arms

Mesh Chair Range

Mesh Chairs not only provide excellent ventilation and breathability keeping the user cool, comfortable and dry, minimise the risk of muscular fatigue throughout the working day but also provide a modern, fresher looking workspace.

Chair Dimension Codes

SW = Seat Width

SD = Seat Depth

BH = Back Height

GH = Gas Height Range



FABRICS
Black



WMCC

SW 470mm
SD 470mm
BH 500mm
Mesh Back with Fabric Seat, Cantilever Chrome Frame and Arms

WM600

FABRICS
Black Mesh



SW 510mm
SD 420mm
GH 480-590mm
Ideal Meeting Chair with Chrome Base and Arms, Comfortable Mesh Material

VIENNA

FABRICS
Black
Red
Lime
Blue
Silver



SW 490mm
SD 490mm
GH 430-550mm
Mesh Back Chair Suitable for Home Office or Light Commercial Use

WMVBK

FABRICS
Black



SW 480mm
SD 480mm
BH 480mm
Mesh Back Visitor or Meeting Chair with Arms and Chrome Legs

VESTA

FABRICS
Black



SW 460mm
SD 460mm
GH 430-530mm
Mesh Back Chair with Fabric Seat, Suitable for Home Office Use

RE100

FABRICS
Black



SW 510mm
SD 500mm
GH 470-590mm
Plastic Perforated Back, Single Point Lock, Arms, Home Office Use

PMVBK

FABRICS
Black



SW 455mm
SD 460mm
BH 300mm
Mesh Back, Plastic Seat with Sled Base, Linking and Stacking Chair

Operator Chair Range

High quality range of operator chairs to suit a range of users.

Chair Dimension Codes

- SW = Seat Width
- SD = Seat Depth
- BH = Back Height
- GH = Gas Height Range

ET20

FABRICS
Black



WARRANTY 3 YEARS

SW	480mm	Medium Back with Gas Lift,
SD	460mm	Back and Seat Tilt,
GH	420-530mm	Injection Moulded Foam

EC070CH

FABRICS
Black
Navy
Charcoal



WARRANTY 3 YEARS

SW	500mm	High Back with Seat and
SD	450mm	Back Tilt, Gas Lift and
GH	470-600mm	Injection Moulded Foam

OPTIONAL EXTRAS



ADJUSTABLE ARMS DRAFTING KIT CHROME BASE

EC070BM

FABRICS
Black
Navy
Charcoal



WARRANTY 3 YEARS

AFRDI LEVEL 6

SW	500mm	AFRDI Level 6, Fully
SD	450mm	Ergonomic Medium Back,
GH	470-600mm	Seat and Back Tilt, Gas Lift

EC070BH

FABRICS
Black
Navy
Charcoal



WARRANTY 3 YEARS

SW	500mm	High Back, Back Tilt,
SD	450mm	Gas Lift and Injection
GH	470-600mm	Moulded Foam Seat

EC070CM

FABRICS
Black
Navy
Charcoal



WARRANTY 3 YEARS

AFRDI LEVEL 6

SW	500mm	AFRDI Tested Level 6, Fully
SD	450mm	Ergonomic Medium Back Chair,
GH	470-600mm	Seat and Back Tilt, Gas Lift

EC070BM DRAFTING CHAIR

FABRICS
Black



WARRANTY 3 YEARS

SW	500mm	Drafting Chair with Medium Back,
SD	450mm	Back Tilt, Gas Lift and Injection
GH	630-800mm	Moulded Foam for Comfort

Chair Dimension Codes

- SW = Seat Width
- SD = Seat Depth
- BH = Back Height
- GH = Gas Height Range



130KG WEIGHT RATING

FABRICS

Black



OPTIONAL EXTRAS



ADJUSTABLE ARMS



DRAFTING KIT



CHROME BASE

ST50



SW 500mm
SD 470mm
GH 460-600mm

AFRDI Level 6, Fully Ergonomic Operator Chair with Tapered Back and Ratchet Back Adjustment, Available in Black or Red Fabric, Adjustable Arms Optional Extra

EG100CH



SW 520mm
SD 480mm
GH 480-620mm

AFRDI Level 6, Fully Ergonomic with Back and Seat Tilt, Gas Lift, High Back, for User up to 130kg

F300



SW 540mm
SD 450mm
GH 510-590mm

Fabric Operator Chair with Ratchet Back, Seat Slide, Chrome Base and Adjustable Arms

PU300



SW 540mm
SD 450mm
GH 510-590mm

Fully Ergonomic Soft PU Chair with Ratchet Back, Seat Slide, Chrome Base and Arms



FABRICS

Black

Navy

Charcoal



FABRICS

Black



FABRICS

Black PU

Operator Chair Range

High quality range of operator chairs and stools.

Chair Dimension Codes

- SW** = Seat Width
- SD** = Seat Depth
- BH** = Back Height
- GH** = Gas Height Range

OPTIONAL EXTRAS



ADJUSTABLE ARMS



DRAFTING KIT



CHROME BASE

EG400



FABRICS

- Black
- Navy
- Charcoal



PO500



FABRICS

- Black
- Navy
- Charcoal
- Black PU



DS DESK



FABRICS

- Black PU

DS COUNTER STOOL



FABRICS

- Black PU

SW	520mm	AFRDI Level 6, Fully Ergonomic with Back and Seat Tilt, Gas Lift, Square Back, for User up to 130kg
SD	480mm	
GH	480-620mm	

SW	530mm	AFRDI Tested Level 6, Fully Ergonomic High Back Chair, Seat and Back Tilt, Gas Lift
SD	510mm	
GH	490-590mm	

SW	400mm	400mm Round Seat Desk Stool, Easy to Clean Black PU Material
SD	400mm	
GH	450-570mm	

SW	400mm	400mm Round Seat Counter Stool, with Drafting Kit, Easy to Clean Black PU Material
SD	400mm	
GH	650-870mm	

Chair Dimension Codes
SW = Seat Width
SD = Seat Depth
BH = Back Height
GH = Gas Height Range

HARTLEY VISITOR



SW 510mm Mesh Back Visitor Chair with Comfortable Fabric Seat
 SD 480mm Black Cantilever Frame
 BH 485mm Adjustable Arms



NEW



FABRICS
Black



CL2000V



FABRICS
Black Leather



SW 510mm Slimline Cantilever Visitor
 SD 500mm Outward Adjust on Arms
 BH 630mm Chrome Arms and Base

WMVBK



FABRICS
Black



SW 480mm Mesh Back, Fabric Seat
 SD 480mm Visitor or Meeting Chair
 BH 480mm Chrome Legs and Arms

WV100 BL



NEW

FABRICS
Black



SW 440mm Comfortable Fabric Chair
 SD 430mm Chrome Sled Base
 BH 450mm

NOVA



FABRICS
Black
Navy
Charcoal



SW 448mm Fabric Seat and Back
 SD 444mm Black Frame
 BH 338mm Linking and Stackable

WMCC



FABRICS
Black

SW 470mm Mesh Back, Fabric Seat
 SD 470mm Stylish Cantilever Frame
 BH 500mm Arms

Chair Dimension Codes

SW = Seat Width

SD = Seat Depth

BH = Back Height

GH = Gas Height Range



FABRICS
Black PU



FERNANDO

SW 425mm
SD 420mm
BH 480mm

Stylish Black PU
Chrome Frame
Stackable

COMFO

FABRICS
Black PU



SW 510mm
SD 490mm
BH 510mm

Visitor or Meeting Chair
Chrome Frame
Cantilever Base

V100

FABRICS
Black
Navy
Charcoal



SW 450mm
SD 450mm
BH 460mm

Comfortable Fabric
Visitor Chair
Stackable

VSB600

FABRICS
Black Fabric
Black PU



SW 490mm
SD 510mm
BH 380mm

Heavy Duty Visitor or
Meeting Chair, Black Sled
Base and Padded Arms

P100

COLOURS
Black



SW 450mm
SD 370mm
BH 405mm

Polypropylene Plastic
Stacking Chair
Available in Black or Grey



Chair Dimension Codes

- SW = Seat Width
- SD = Seat Depth
- BH = Back Height
- GH = Gas Height Range



160KG WEIGHT RATING

FABRICS

Black



NEW



ENDURE 160

SW 530mm High Back, Heavy Duty Task Chair
SD 510mm Italian Synchro Mechanism,
GH 460-560mm Suitable for User up to 160kg - "142" Certification

CL410

FABRICS

Black PU



SW 540mm Soft Black PU with Fabric
SD 500mm Inlay, Infinite Tilt Lock,
GH 450-550mm Chrome Base

CL610

FABRICS

Black PU



SW 494mm Soft Black PU Upholstery,
SD 500mm Single Point Tilt Lock,
GH 450-580mm Medium Back Chair

CL710

FABRICS

Black PU



SW 530mm Soft Black PU Upholstery,
SD 530mm 4 Point Tilt Lock,
GH 460-550mm High Back Chair

CL820

FABRICS

Black PU



SW 520mm Soft Black PU Upholstery,
SD 480mm Infinite Tilt Lock,
GH 420-490mm Chrome Arms and Base

CL2000H



FABRICS

Black Leather



SW 510mm High Back, Black Leather, Multi
SD 500mm Position, Tilt Lock, Outward Adjust
GH 500-565mm on Arms, Polished Aluminium Base

CL2000M



FABRICS
Black Leather



SW 510mm
SD 500mm
GH 500-565mm
Medium Back, Outward Adjust on Arms, Slimline, Multi Position Lock Tilt

CL2000V



FABRICS
Black Leather



SW 500mm
SD 500mm
BH 630mm
Cantilever Visitor, Slimline Chrome Frame, Outward Adjust on Arms



FABRICS
Black Leather



LANDER

SW 510mm
SD 510mm
GH 480-580mm
Fully Ergonomic, 3 Lever Heavy Duty Mechanism Executive Chair with Black Leather and Adjustable Arms as Standard Suitable for User up to 150kg and 24/7 Heavy Duty Use

Chair Dimension Codes

SW = Seat Width
SD = Seat Depth
BH = Back Height
GH = Gas Height Range

PU605M



FABRICS
Black PU



SW 485mm
SD 460mm
GH 490-610mm
Medium Back, Infinite Lock Tilt, Chrome Arms and Base, Black PU

PU605H



FABRICS
Black PU



SW 485mm
SD 460mm
GH 490-610mm
High Back, Infinite Lock Tilt, Chrome Arms and Base, Black PU

PU900M



FABRICS
Black PU



NEW

SW 520mm
SD 435mm
GH 460-545mm
Medium Back with Upholstered Black PU Seat and Back, Single Point Lock, Polished Aluminium Base

ZOOM



FABRICS
Black



NEW

ZOOM TABLET for use with Zoom Chair ONLY.



SW	460mm	Mesh Back with Back Rest Tilt, Foldable Training and Conference Chair, with Optional Extra Foldable Tablet Arm.
SD	490mm	
BH	330mm	

WIMBLEDON



COLOURS
Black



SW	425mm	Plastic Seat and Back, Chrome Sled Base Linking and Stackable
SD	430mm	
BH	245mm	



With Arms



Tablet Arm



Seat & Back Pad



Custom Upholstery (Lead Time applies)

COLOURS
Black



Trolley available for ZEST, PMVBK, ZOLA, ZING and WIMBLEDON Chairs ONLY.

ZOLA



COLOURS
Black



SW	460mm	Plastic Seat and Back, Chrome Frame, Stacking
SD	440mm	
BH	200mm	

ZEST



COLOURS
Black



SW	445mm	Conference or Meeting Chair, Chrome Sled Base, Linking and Stackable
SD	450mm	
BH	310mm	

ZING



COLOURS
Black



SW	465mm	Large Back and Seat, Optional Extra: Arms, Linking and Stackable
SD	430mm	
BH	370mm	

Chair Dimension Codes

SW = Seat Width

SD = Seat Depth

BH = Back Height

GH = Gas Height Range



COLOURS

Black

White

Red



TAURUS BAR STOOL

SW	435mm	Indoor Hospitality Stool with Chrome Base, 750mm Seat Height 1050mm Overall Height
SD	455mm	
BH	345mm	

LEO

COLOURS

Black

White

Red



SW	420mm	Suitable for Indoor or Outdoor Use, Aluminium Legs
SD	410mm	
BH	420mm	

Hospitality Chair Range

Compliment your café, lunch room or breakout areas with our comfortable and contemporary hospitality seating options.

TAURUS

COLOURS

Black

White

Red



SW	490mm	Indoor Hospitality Chair Chrome Base, Available in Red, Black or White
SD	510mm	
BH	380mm	

PIPEE

COLOURS

White

Grey

Green



SW	400mm	Polypropylene Plastic Stacking Chair, Holds up to 150kg, High Luster Shine
SD	380mm	
BH	410mm	



Ottoman Range

Soft Seating Ottomans provide communal, breakout and collaboration qualities to your office space. Choose from a variety of shapes, sizes & styles.

Ottoman Dimension Codes

SW = Seat Width

SD = Seat Depth

H = Height

MARS ROUND

NEW

FABRICS
Charcoal



SW 550mm Upholstered Round
SD 550mm Ottoman,
H 450mm Charcoal Fabric

MARS SQUARE

NEW

FABRICS
Charcoal



SW 550mm Upholstered Square
SD 550mm Ottoman,
H 450mm Charcoal Fabric

MARS TRIANGLE

NEW

FABRICS
Charcoal



SW 550mm Upholstered Triangle,
SD 550mm Ottoman,
H 450mm Charcoal Fabric

VENUS OTTOMAN

FABRICS
Black PU



SW 1030mm Use as an Ottoman or Foot
SD 540mm Stool, Black PU Finish and
H 410mm Stainless Steel Frame

CONNECT 2 OTTOMAN

NEW

FABRICS
Black PU



SW 320mm Black Fabric Seat, White
SD 320mm Powdercoated Steel
H 420mm Base, User up to 110kg



CORNER LOZENGE



Converts Desk and Return to a Corner Workstation
Will fit 25mm or 33mm D Tops
LOZENGE25 250W x 480L x 25D
LOZENGE33 250W x 480L x 33D

CHAIR MATS



Dimpled for use on Carpet, Smooth for Hard Floors
MAT S Small Dimpled 915W x 1200L x 20D
MAT L Large Dimpled 1140W x 1350L x 20D
MAT SM S Small Smooth 915W x 1200L x 20D
MAT SM L Large Smooth 1140W x 1350L x 20D

DOUBLE SIDED WHITEBOARD



Double Sided Pivoting Mobile Whiteboard, includes Pen Tray
M129 1200W x 900H x 15D
M159 1500W x 900H x 15D
M189 1800W x 900H x 15D

CORKBOARDS



Composite Corkboard
Aluminium Frame
Suitable for Pins or Stickers
C96 900W x 600H x 15D
C129 1200W x 900H x 15D

PINBOARDS



Includes 6 Pins

Grey Fabric Covered Commercial Pin Board, Brushed Aluminium Frame, Grey Fabric ONLY
Wall Fix via Concealed Corner Fix
PIN96 600W x 600H x 15D
PIN129 1200W x 900H x 15D

WALL MOUNTED WHITEBOARD



- Wall Mounted Aluminium Framed Magnetic Whiteboard
- Pen Tray
- Concealed Corner Fixing
- Acrylic Polyester Resin Surface
- 4 Magnets Included

W96 900W x 600H x 15D
W129 1200W x 900H x 15D
W159 1500W x 900H x 15D
W189 1800W x 900H x 15D
W1812 1800W x 1200H x 15D
W219 2100W x 900H x 15D

DESK MOUNTED SCREENS



Flat Top, Clamp or Screw Fix to Workstation, Pinable Fabric

DMSF705 700W x 500H x 30D
DMSF1205 1200W x 500H x 30D
DMSF1505 1500W x 500H x 30D
DMSF1805 1800W x 500H x 30D

SCREEN COLOURS

Grey
Blue

ACOUSTIC SCREENS



Free Standing Dividing Office Panels, 50mm Thick, Pinable, Black PVC Edging and Silver Feet

1515SCREEN 1500W x 1500H x 50D
1518SCREEN 1500W x 1800H x 50D
1815SCREEN 1800W x 1500H x 50D
1818SCREEN 1800W x 1800H x 50D

SCREEN COLOURS

Grey
Blue





Personal Workstation Steel Storage Range

The Rapidline under desk storage range provides convenience, security and durability with ball-bearing drawer suspension, robust steel construction and anti-tilt mechanisms.

RAPIDLINE MOBILE PEDESTAL



- COLOURS
- Black Satin
 - White China
 - Precious Silver
 - Graphite Ripple

Rapidline Mobile Pedestal
Lockable, Full Extension Ball Bearing Runners, Flush Drawer Front, Fifth Wheel for Stability
GMP3 3 Drawers 460W x 472D x 610H

SLIMLINE MOBILE PEDESTAL



- COLOURS
- White China

Slimline Mobile Pedestal
Ideal for Smaller Workstations to allow for Extra Leg Room, Available in White ONLY.
GSP3 3 Drawers 300W x 472D x 610H

RAPIDLINE MOBILE CADDY



Rapidline Mobile Caddy - Available in White ONLY.
Flush Front Mobile Pedestal with Tambour Door Section with Centre Shelf, Fully Lockable
Ideal for Hot Desks or Workstation Return, Seat Cushion Available (Lead Time applies)
GCAD L Tambour Door Left Hand 1050W x 460D x 570H
GCAD R Tambour Door Right Hand 1050W x 460D x 570H



- COLOURS
- White China



Shelving Steel Storage Range

Declutter your office space and archive like a professional.

RAPIDLINE SHELVING UNIT

GSC9422 2200H X 910W X 400D

- Flat packed, easy assembly
- Includes 5 shelves
- Available in Silver Grey only



COLOURS

Silver Grey

RAPIDLINE BOLTLESS

GV189 1830H X 914W X 457D

GV1812 1830H X 1220W X 457D

- Heavy duty, includes shelves as shown
- Available in Silver Grey only

RAPIDLINE MOBILE SHELVING

- Space Efficient Method of Bulk Storage
- Easy to Level and Relocate Base
- 110kg Shelf Capacity
- White Powdercoat Finish, Lockable

4 BAY 2670L X 980W X 2150H
2670L X 1280W X 2150H

6 BAY 3560L X 980W X 2150H
3560L X 1280W X 2150H

8 BAY 4450L X 980W X 2150H
4450L X 1280W X 2150H

- With 4 Adjustable Shelves
- White only



COLOURS

White



LOCKERS

COLOURS
 White China
 Silver Grey



SINGLE DOOR
GL305/1 305W x 455D x 1830H
GL380/1 380W x 455D x 1830H
 - 380W in Silver ONLY

- Riveted Construction for Extra Strength
- Fitted with Hat Shelf and Coat Rail
- Vented Doors



2 DOOR
GL305/2 305W x 455D x 1830H
GL380/2 380W x 455D x 1830H
 - 380W in Silver ONLY

- Riveted Construction for Extra Strength
- Fitted with Coat Hook to each Compartment
- Vented Doors



4 DOOR
GL305/4 305W x 455D x 1830H
GL380/4 380W x 455D x 1830H
 - 380W in Silver ONLY

- Riveted Construction for Extra Strength
- Full Length Stiffeners Fitted to each Door
- Vented Doors



STEP LOCKER
 Allows 2 Hanging Spaces in 380W Locker

- Available in Silver Grey ONLY.
- 380W x 455D x 1830H
- Vented Doors



STAND ONLY
SB2305
 Stand ONLY for Bank of 2 x 305W Lockers
SB3305
 Stand ONLY for Bank of 3 x 305W Lockers



30° SLOPING TOP
G12830 Single
G32830 Bank of 3

Available for 305W Lockers ONLY.



BENCH SEAT
BS1000
 1000mm Wide Bench Seat
 Silver Grey ONLY.



SEAT & STAND
S+S2305
 Seat and Stand for Bank of 2 x 305W Lockers
 Silver Grey ONLY.

S+S3305
 Seat and Stand for Bank of 3 x 305W Lockers
 Silver Grey ONLY.

GO TAMBOUR DOOR CUPBOARDS AND ACCESSORIES



PLAIN SHELF

GTD900 900W
GTD1200 1200W



SLOTTED SHELF & DIVIDERS

GG09SLOT 900W
GG12SLOT 1200W
GS7D 5 Dividers



PULL OUT SHELF

GG09PS 900W
GG12PS 1200W



CLIP ON DIVIDERS

GSD6 175H



ROLL OUT FILING FRAME

GG09FF 900W
GG12FF 1200W



PLANTER BOX

PB 900 900W X 470D X 230H
PB 1200 1200W X 470D X 230H



- (1016H, 1200H or 1981H) x (900W or 1200W) x 473D
- Adjustable feet, easy glide track and magnetic slam rail

COLOURS

White China

Silver Grey

GO LATERAL FILING CABINETS



2 DRAWER

GLF2
▪ 705H X 900W X 473D



3 DRAWER

GLF3
▪ 1016H X 900W X 473D



4 DRAWER

GLF4
▪ 1321H X 900W X 473D



GO CUPBOARDS



- GCA10**
1015H X 910W X 450D
▪ Includes 2 Shelves
- GCA18**
1830H X 910W X 450D
▪ Includes 3 Shelves
- GCA20**
2000H X 910W X 450D
▪ Includes 4 Shelves
- GCWSG**
Shelf and Coat Rail
▪ Silver Grey only



- Flush Lock with 2 Keys
- Available assembled or flat pack
- Tested to British Standards
- Available in Silver Grey, Graphite Ripple or White

GO STEEL FILING CABINETS



- Heavy duty, available in 4 Colours
- Fully Riveted with Ball Bearing Runners
- 40+ KG per drawer
- Tested to AFRDI Level 6

- GFCA2** 705H X 460W X 620D
- GFCA3** 1016H X 460W X 620D
- GFCA4** 1321H X 460W X 620D

COLOURS
Black Ripple
White China
Silver Grey
Graphite Ripple



GO WARDROBE



- GO WARDROBE**
1830H X 910W X 450D
Hanging and Storage Space - Silver Grey only

RAPIDLINE FILING CABINETS



- 30+ KG per drawer
- Ball Bearing Runners
- Commercial quality,
- Available assembled or flat pack
- Available in Silver Grey, White China and Graphite Ripple

- RFCA2** 675H X 464W X 620D
- RFCA3** 980H X 464W X 620D
- RFCA4** 1290H X 464W X 620D

COLOURS
White China
Silver Grey
Graphite Ripple