

nexus
interiors
— australia

Task seating
Desks & Workstations
Visitor seating
Soft seating
Zorb Acoustics

Nexus Interiors Australia Catalogue

2018





TASK

Alpha-Logic

08

Apollo

09

Atlas

10-11

Bodyline

12-13

Cobi

14

Contempo

14

Delta Range

16-17

Director

18

Domino

19

Ergomax

20

Ergopedic

20

GM

21

Kinetic

22-23

Quattro

24

Rexa Range

25

Team Air Range

26-27

Utility Drafting

28

Utility Lab

29

Why

30-31

DESK & WORKSTATIONS

Ascend





32-33

How to choose your task chair.



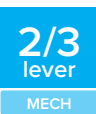
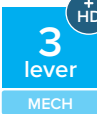

Our chair mechanisms provide a full range of adjustments to suit particular tasks and individual needs. All mechanisms have been selected after hours of continuous testing. All CS mechanisms are fitted with top quality pneumatic height adjustable gaslifts, which meet the highest standard – Class 4.

Relevant mechanisms and other components have been independently tested to AS/NZS 4438:1997 by Furntech-AFRDI.



It's All About The Mech

 <p>2/3 lever MECH</p>	<p>2 LEVER Seat height Back tilt</p>	<p>3 LEVER Seat height Back tilt Seat tilt</p>	 <p>3 lever MECH</p>	<p>3 LEVER HEAVY DUTY Additional reinforcement for larger users.</p>	 <p>3 lever MECH</p>	<p>SUPER HEAVY DUTY Significantly reinforced to comfortably pass AFRDI 142 Rated Load 160kg Multiple Shift.</p>
 <p>sync MECH</p>	<p>SYNCHRONISED Seat and back tilt in a synchronised movement.</p>		 <p>A sync MECH</p>	<p>A SYNCHRONISED Seat and back tilt independently.</p>	 <p>swivel tilt MECH</p>	<p>SWIVEL / KNEE TILT Fixed back and seat with tilt mechanism.</p>

Features Icons

 <p>5/10 year WARRANTY</p>	<p>WARRANTY Replace or repair on all chair components.*Excludes fabric.</p>	 <p>MADE</p>	<p>AUSTRALIAN MADE These products are proudly made throughout Australia from local and imported components.</p>
 <p>160 kg MAX USER</p>	<p>MAX USER RATINGS Chair Solutions recommends these products for users up to its max user weight. These products are supported by our warranty policy.</p>	 <p>ANY FABRIC</p>	<p>ANY FABRIC Chair is upholstered in any fabric of your choice.</p>

Certification

	<p>AFRDI LEVEL 6 Certified Level 6 office chairs will meet most commercial needs. Level 6 chairs should be able to withstand extremely severe conditions of use, such as police stations, military installations, control rooms and use in heavy industry.</p>
	<p>AFRDI 142-Rated Load 160kg/135kg This standard is designed to cater for people heavier than 110kg.</p>
<p>Multi-shift</p>	<p>For multiple shift operation i.e. significantly greater than 40hrs use per week</p>
<p>Single-shift</p>	<p>For single 8 hour shift operations. i.e. approximately 40hrs use per week</p>



GECA
Australia's trusted eco-label for planet and people.

Good Environmental Choice Australia empowers architects, builders, designers and consumers to have confidence in their purchasing decisions, and trust GECA certified products to be healthier, safer, and better for the environment.

ChairSolutions offer a range of GECA certified products

Seat Sizes

Sizes in mm

CS seat sizes allow every user to find their fit.



SMALL

AVAILABLE ON: Alpha-logic



STANDARD

Atlas-task, Delta, Bodyline, Rexa, Team-Air Task



PLUS

Atlas-160, Delta Plus, Bodyline Plus, Rexa Plus, Team-Air Heavy-duty



PLUS XL

Atlas, Delta Plus XL, Rexa



PLUS 2XL

Atlas, Delta Plus 2XL, Rexa

Chair accessories



Steel foot-ring



Height adjustable arms

3D Adjustable arms

– Available on all as upgrade



Low gaslift

– Adjustment range of 80 to 120mm

Standard gaslift

– Adjustment range of 140mm.



Intermediate gaslift

– Adjustment range of 200mm

Drafting gaslift

– Adjustment range of 280mm.

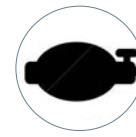

Inflatable Lumbar



Seat Slide

Base Options



Polished alloy base



Polished hi-arch alloy base



AFRDI Certified Drafting conversion kit.



GECA Certified Drafting conversion kit.

Castor Options



Locking Castors

– Sit-lock/ Sit-move
– Wheels freely when users weight is on the chair, locks when there is no weight on it.



Brake castors

– Brake feature is manually activated by a small lever on the castor.



Soft tyre castors

– 50mm
– 60mm



Heavy Duty castors

– 60mm
– Allows the chair to wheel more freely than a standard castor.

Alpha-Logic

The best value AFRDI level 6 task chair on the market. Available in two or three lever, mid or high-back.

Certification

AFRDI Level 6 - Alpha-Logic Mid-back 3L, Alpha-Logic High-back 3L, (with/without arms, & alloy-base)

POPULAR OPTIONS – See p.7 for more options

CASTORS Hard-floor, Glides,
ARMS Height Adjustable Arms
FABRIC Your choice of **any fabric**.



Alpha-Logic High-back

- 490mm back with 110mm height range.
- AFRDI Level 6 certified to severe commercial use.
- Australian made from local and imported components.
- 5 year Aus. manufacturer warranty.

Seat Size (mm)	480W x 450D
Seat Height (mm)	From 420 to 530
Back Size (mm)	450W x 490H
Certification	AFRDI Level 6



ALPHA-LOGIC HIGH-BACK

- Popular Option



with optional adjustable arms.

- Popular Option



with optional alloy star-base and arms.



CS-XPRESS – Next Day Delivery

Alpha-Logic Mid-back

- 400mm back with 110mm height range.
- AFRDI Level 6 certified to severe commercial use.
- Australian made from local and imported components.
- 5 year Aus. manufacturer warranty.

Seat Size (mm)	480W x 450D
Seat Height (mm)	From 420 to 530
Back Size (mm)	440W x 400H
Certification	AFRDI Level 6



ALPHA-LOGIC MID-BACK

- Popular Option



with optional adjustable arms.

- Popular Option



with optional alloy star-base and arms.

- Popular Fabric



upholstered in black.

Alpha-Logic Drafting

- 400mm back with 250mm height range.
- Adjustable height foot-ring.
- Australian made from local and imported components.
- 5 year Aus. manufacturer warranty.

Seat Size (mm)	480W x 450D
Seat Height (mm)	From 590 to 840
Back Size (mm)	440W x 400H



ALPHA-LOGIC DRAFTER

- Popular Option



with optional adjustable arms.

- Popular Option



with optional glides.

Apollo

Italian designed with Essentia seat and Apollo back with optional adjustable arms. Hi-Arch plastic black base standard. GECA & AFRDI 6.

Certification

AFRDI Level 6 - Apollo Task M/B,
Apollo Task H/B,
Apollo Exec M/B,
Apollo Exec H/B
(with/without arms, & alloy-base)

POPULAR OPTIONS – See p.7 for more options

CASTORS Hard-floor, Glides,
ARMS Height Adjustable Arms
FABRIC Your choice of **any fabric**.



 MADE	10 year WARRANTY	 ANY FABRIC	135 kg MAX USER	3 lever MECH ^{HD}
---	-------------------------------	---	------------------------------	---

Apollo Task

- AFRDI Level 6 certified to severe commercial use.
- Australian made from local and imported components.
- 10 year Aus. manufacturer warranty.

Seat Size (mm)	490W x 465D
Seat Height (mm)	From 450 to 570
Back Size (MB)	440W x 390H
Back Size (HB)	460W x 545H
Certification	AFRDI Level 6



APOLLO HIGH-BACK



with optional adjustable arms.



APOLLO MID-BACK



with optional adjustable arms.

Apollo Executive

- AFRDI Level 6 certified to severe commercial use.
- Australian made from local and imported components.
- 10 year Aus. manufacturer warranty.

Seat Size (mm)	490W x 465D
Seat Height (mm)	From 450 to 570
Back Size (MB)	440W x 390H
Back Size (HB)	460W x 545H
Certification	AFRDI Level 6



APOLLO HIGH-BACK



with optional alloy star-base and arms.



APOLLO MID-BACK



with optional alloy star-base and arms.

Apollo Drafting

- Adjustable height foot-ring.
- Australian made from local and imported components.
- 10 year Aus. manufacturer warranty.

Seat Size (mm)	490W x 465D
Seat Height (mm)	From 590 to 840
Back Size (mm)	440W x 390H



APOLLO DRAFTER



with optional adjustable arms.



with optional glides

Atlas 160

Atlas-160 is a super heavy duty chair, up to 160kg loads. 3 lever super heavy duty manual mechanism. Extra heavy duty gas lift. AFRDI 142 160kg tested.

Certification

AFRDI 142-Rated Load 160kg S/S - Atlas-160

POPULAR OPTIONS – See p.7 for more options

BASES Polished hi-arch alloy base
 ARMS Height Adjustable Arms,
 SEATS Plus XL, Plus 2XL
 FABRIC Your choice of **any fabric**.

 MADE	10 year WARRANTY	 ANY FABRIC	135/160 kg MAX USER	3 lever MECH ^{SHD}
---	--------------------------------------	---	---	---



Atlas 160

- For users up to 160kg, as certified by AFRDI 142-Rated Load.
- Plus seat using Australian made moulded foam.
- Manual back adjustment, allowing a more precise setting.
- 10 year Aus. manufacturer warranty.

Seat Size (mm)	520W x 490D
Seat Height (mm)	From 420 to 560
Back Size (mm)	480W x 530H
Certification / Max User	AFRDI 142-Rated Load 160kg S/S

- Popular Option



ATLAS-160

with optional arms.

CS-XPRESS –
Next Day Delivery

Atlas 135

- The little brother to the Atlas-160 with the same durability & comfort for users up to 135kg.
- Standard seat using Australian made moulded foam.
- Manual back adjustment, allowing a more precise setting.
- 10 year Aus. manufacturer warranty.

Seat Size (mm)	490W x 465D
Seat Height (mm)	From 420 to 560
Back Size (mm)	440W x 440H
Max User	135kg

- Popular Option

- Popular Option



ATLAS-135

with optional adjustable arms.

with optional alloy star-base.

with drafting conversion kit.

USER Case Study

NSW Police trialled the Atlas-160 to meet their rigorous strength, stability & safety requirements. After trialling, NSW Police force are now supported by the durability and comfort of the Atlas-160.



Bodyline

The Bodyline Task chair is designed to face the rigorous demands of today's office environment.

 MADE	10 year WARRANTY	 ANY FABRIC	120/135 kg MAX USER	3 lever MECH
---	--------------------------------------	---	---	----------------------------------



Certification

AFRDI Level 6 - Bodyline Mid-back
Bodyline High-back
Bodyline Plus Mid-back
Bodyline Plus High-back

POPULAR OPTIONS – See p.7 for more options

CASTORS	60mm, Hard-floor,
GASLIFTS	Low, Intermediate
STARBASE	Polished Alloy/ Hi-arch
ARMS	Height Adjustable Arms,
FABRIC	Your choice of any fabric .
SEAT	Comfort Duo Optional

Bodyline High-back

- Fully upholstered inner and outer back.
- Standard seat using Australian made moulded foam.
- AFRDI Level 6 certified to severe commercial use.
- 10 year Aus. manufacturer warranty.

Seat Size (mm)	490W x 465D
Seat Height (mm)	From 420 to 560
Back Size (mm)	450W x 520H
Max User	120 kg
Certification	AFRDI Level 6



BODYLINE HIGH-BACK

- Popular Option



with optional adjustable arms.

- Popular Option



with optional alloy star-base and arms.

Bodyline Mid-back

- Fully upholstered inner and outer back.
- Standard seat using Australian made moulded foam.
- AFRDI Level 6 certified to severe commercial use.
- 10 year Aus. manufacturer warranty.

Seat Size (mm)	490W x 465D
Seat Height (mm)	From 420 to 560
Back Size (mm)	420W x 480H
Max User	120 kg
Certification	AFRDI Level 6



BODYLINE MID-BACK

- Popular Option



with optional adjustable arms.

- Popular Option



with optional alloy star-base and arms.

Bodyline Plus High-back

- Fully upholstered inner and outer back.
- Plus seat using Australian made moulded foam.
- AFRDI Level 6 certified to severe commercial use.
- 10 year Aus. manufacturer warranty.

Seat Size (mm)	520W x 490D
Seat Height (mm)	From 420 to 560
Back Size (mm)	450W x 520H
Max User	135 kg
Certification	AFRDI Level 6



BODYLINE PLUS HIGH-BACK

- Popular Option



with optional adjustable arms.

- Popular Option



with optional alloy star-base and arms.

Bodyline *Plus Mid-back*

- Fully upholstered inner and outer back.
- Plus seat using Australian made moulded foam.
- AFRDI Level 6 certified to severe commercial use.
- 10 year Aus. manufacturer warranty.

Seat Size (mm)	520W x 490D
Seat Height (mm)	From 420 to 560
Back Size (mm)	420W x 480H
Max User	135 kg
Certification	AFRDI Level 6

- Popular Option



**BODYLINE PLUS
MID-BACK**

- Popular Option



with optional
adjustable arms.



with optional alloy
star-base and arms.

Cobi & Contempo

Executive Seating

Stylish and contemporary meeting or boardroom chairs. Cobi comes standard with a black fabric seat, black mesh and fixed arms. Contempo has slim-lines and bold sewn detail characteristics in a black leather finish.

	3 year	120 kg	swivel tilt
MADE	WARRANTY	MAX USER	MECH

Optional components available.
– See p.07

Cobi

- Fixed slim lines.
- Generous 520mm wide seat.
- Simple to use tilting mechanism.

Seat Size (mm)	520W x 500D
Seat Height (mm)	From 420 to 560
Back Size (mm)	470W x 590H



COBI

optionally
without arms.

Contempo High-back

- Fixed chrome arms.
- 610mm back height.
- Classic board room style.

Seat Size (mm)	510W x 510D
Seat Height (mm)	From 450 to 530
Back Size (mm)	450W x 610H



CONTEMPO
HIGH-BACK

Contempo Mid-back

- Fixed chrome arms.
- 480mm back height.
- Classic board room style.

Seat Size (mm)	510W x 510D
Seat Height (mm)	From 450 to 530
Back Size (mm)	450W x 480H

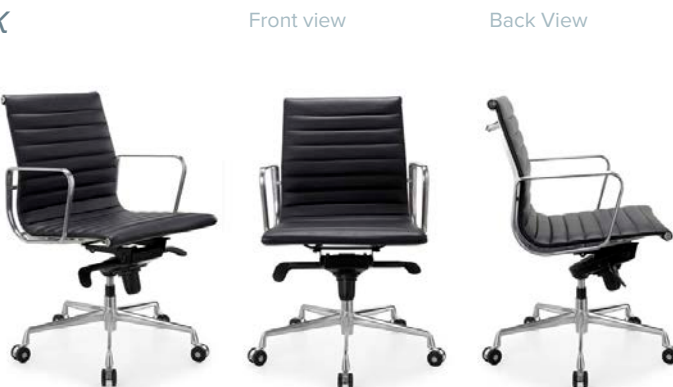

CONTEMPO
MID-BACK



Delta Range

Our Ultimate Ergonomic All Rounder. Designed to fit every body shape and size. The Delta Range consists of three back and four seat sizes. These can be mixed and matched to fit the individual, big or small, tall or short and anywhere in between.



Certification

AFRDI Level 6 – Delta Mid-back 2L/3L, Delta High-back 2L/3L, Delta Plus Mid-back 3L, Delta Plus High-back 3L, (with/without arms, & alloy-base)

POPULAR OPTIONS – See p.7 for more options

CASTORS	60mm, Hard-floor,
GASLIFTS	Low, Intermediate
STARBASE	Polished Alloy/ Hi-arch
ARMS	Height Adjustable Arms,
FABRIC	Your choice of any fabric .
SEAT	Comfort Duo Optional

Delta

- Multiple configurations are AFRDI Level 6 certified to severe commercial use.
- Standard seat using Australian made moulded foam.
- Variable back heights to fit every user.

Seat Size (mm)	490W x 465D
Seat Height (mm)	From 420 to 530
Back Size MB (mm)	410W x 410H
Back Size HB	450W x 500H
Back Size XHB	490W x 590H
Max User	Warranted to 120kg
Certification	AFRDI Level 6



DELTA
Mid-back

High-back.

Extra High-back.

Mesh back.

Delta Plus

- Multiple configurations are AFRDI Level 6 certified to severe commercial use.
- Plus seat using Australian made moulded foam.
- Variable back heights to fit every user.

Seat Size (mm)	520W x 490D
Seat Height (mm)	From 420 to 530
Back Size MB (mm)	410W x 410H
Back Size HB	450W x 500H
Back Size XHB	490W x 590H
Max User	Warranted to 135kg
Certification	AFRDI Level 6



DELTA PLUS
Mid-back

High-back.

Extra High-back.

Delta Plus XL/2XL

- Recommended for larger users up to 135kg.
- XL contoured seat or 2XL using Australian made moulded foam.
- Variable back heights to fit every user.

Seat Size XL (mm)	540W x 500D
Seat Size 2XL (mm)	560W x 510D
Seat Height (mm)	From 420 to 530
Back Size MB (mm)	410W x 410H
Back Size HB	450W x 500H
Back Size XHB	490W x 590H
Max User	Warranted to 135kg



DELTA PLUS XL
High-back

Extra High-back.

DELTA PLUS 2XL
High-back with optional arms

Extra High-back.



Delta Plus *Comfort Duo*

Our Comfort Duo seat foam ensures that your body is maintained in the optimum support position throughout the day, enhancing your productivity and wellbeing. Softer foam at the back of the seat supports the pelvis in the correct position.



DELTA PLUS
Mid-back

High-back.

Extra High-back.

Director Executive

Director, Luxuriously appointed family of Executive chairs. Available in high and medium back, mechanism with 5 point locking, knee tilt and standard with alloy base.

POPULAR OPTIONS – See p.7 for more options

CASTORS
STARBASE
FABRIC

Hard-floor,
Polished Alloy Star-base,
Upholstered in any fabric
vinyl or leather.



Director

- Classic boardroom style.
- 5 year Aus. manufacturer warranty.
- Upholstered in your choice of fabric.

Seat Size (mm)	530W x 490D
Seat Height (mm)	From 450 to 530
Back Size (MB)	530W x 580H
Back Size (HB)	530W x 660H



DIRECTOR HIGH-BACK



upholstered in blue fabric.



DIRECTOR MID-BACK



upholstered in blue fabric.

Domino₂

Since it was first introduced in 1995, the Domino has under gone a number of transformations. The latest variation has improved lumbar support and adjustment. The durability and functionality allows this mesh chair to offer great support throughout the workplace.

 MADE	10 year WARRANTY	 ANY FABRIC	135 kg MAX USER	SYNC MECH
---	-------------------------------	---	------------------------------	---------------------

Certification

AFRDI 142-Rated Load 135kg S/S - Domino 2

POPULAR OPTIONS – See p.7 for more options

CASTORS	Hard-floor,
STARBASE	Polished Alloy Star-base,
ARMS	3D Adjustable Arms,
FABRIC	Your choice of any fabric .



Domino₂

- For users up to 135kg, as certified by AFRDI 142-Rated Load.
- Lockable Synchronised Mechanism with adjustable tension control.
- Seat slide to provide more depth for the user.
- Optional Italian Designed multi-directional 3D arms.
- 10 year Aus. manufacturer warranty.

Seat Size (mm)	500W x 460D
Seat Height (mm)	From 420 to 520
Back Size (mm)	490W x 500H



DOMINO 2

- Popular Option



with optional 3D adjustable arms.

- Popular Option



with black fabric.

Domino₂ Executive

- With polished alloy high-arch base
- For users up to 135kg, as certified by AFRDI 142-Rated Load.
- Lockable Synchronised Mechanism with adjustable tension control.
- Seat slide to provide more depth for the user.
- Optional Italian Designed multi-directional 3D arms.
- 10 year Aus. manufacturer warranty.

Seat Size (mm)	500W x 460D
Seat Height (mm)	From 420 to 520
Back Size (mm)	490W x 500H



DOMINO 2 EXECUTIVE

- Popular Option



with optional 3D adjustable arms.

- Popular Option



with black Italian leather.

Ergomax & Ergopedic

The Ergopedic reduces pressure and provides a reduction of heat build up, whilst benefiting blood circulation. It is the perfect choice for users with back issues or requirements for extended sitting periods. Ergomax comes standard with an extra heavy duty gas lift and heavy duty alloy base, allowing this chair to accommodate weights up to 160kgs.

POPULAR OPTIONS – See p.7 for more options

CASTORS Hard-floor,
 STARBASE Polished Alloy Star-base,
 ARMS 3D Adjustable Arms,
 FABRIC Your choice of **any fabric**.
 SEAT Comfort Duo Optional

 MADE	10 year WARRANTY	 ANY FABRIC	135/160 kg MAX USER	3 lever MECH ^{SHD}
---	--------------------------------------	---	---	---

Ergomax

- 570mm high back.
- Plus 2XL seat made from moulded foam.
- 3 lever super heavy duty mechanism.
- 10 year Aus. manufacturer warranty.

Seat Size (mm)	520W x 490D
Seat Height (mm)	From 450 to 580
Back Size (mm)	480W x 570H
Max User	135kg

- Front View



ERGOMAX



with optional 3D adjustable arms.



upholstered in black fabric.

Ergopedic

- 620mm high back.
- Plus XL seat made from moulded foam.
- 3 lever heavy duty mechanism.
- 10 year Aus. manufacturer warranty.
- Visco gel overlay for comfort.

Seat Size (mm)	530W x 510D
Seat Height (mm)	From 420 to 520
Back Size (mm)	480W x 620H
Max User	160kg

- Front View



ERGOPEDIC



- Back View



upholstered in black fabric.

Ergopedic Controller

- Designed for longer working hours.
- Contemporary stitching detail.
- 3 lever heavy duty mechanism.
- 10 year Aus. manufacturer warranty.
- Visco gel overlay for comfort.



ERGOPEDIC CONTROLLER

GM Executive

Generously sized traditional executive chair with 5 point multi-locking mech. Upholstered in high grade black leather with alloy arms and 5 star base.

POPULAR OPTIONS – See p.7 for more options

CASTORS Hard-floor,
STARBASE Polished Alloy Star-base,

	5 year	120 kg	swivel tilt
MADE	WARRANTY	MAX USER	MECH

GM High-back

- Polished alloy base
- 5-point multi-locking mech.
- High-grade black leather

Seat Size (mm)	520W x 520D
Seat Height (mm)	From 450 to 520
Back Size (mm)	520W x 700H



**GM
HIGH-BACK**

GM Mid-back

- Polished alloy base
- 5-point multi-locking mech.
- High-grade black leather

Seat Size (mm)	520W x 520D
Seat Height (mm)	From 450 to 520
Back Size (mm)	520W x 580H



**GM
MID-BACK**

Kinetic

Unique A-synchronised mechanism allows the seat and back to move independently of each other. The chair will follow your precise movement all day long. The A-synchronised mechanism optimises Italian engineering.

POPULAR OPTIONS – See p.7 for more options

CASTORS Hard-floor,
 STARBASE Polished Alloy Hi-arch
 ARMS 3D Adjustable Arms,
 FABRIC Your choice of **any fabric**.

 MADE	10 year WARRANTY	 ANY FABRIC	135 kg MAX USER	A sync MECH
---	-------------------------------	---	------------------------------	--------------------------

Kinetic High-back

- A-synchronised mechanism allows the seat and back to move independently.
- Unique Push-button back height adjustment provides 80mm height range.
- Seat slide to provide more depth.
- Optional Italian designed multi-directional 3D arms.
- 10 year Aus. manufacturer warranty.

Seat Size (mm)	490W x 465D
Seat Height (mm)	From 450 to 520
Back Size (mm)	440W x 540H



KINETIC HIGH-BACK

- Popular Option



with optional 3D adjustable arms.

- Popular Option



with optional alloy star-base and arms.

Kinetic Mid-back

- A-synchronised mechanism allows the seat and back to move independently.
- Unique Push-button back height adjustment provides 80mm height range.
- Seat slide to provide more depth.
- Optional Italian designed multi-directional 3D arms.
- 10 year Aus. manufacturer warranty.

Seat Size (mm)	490W x 465D
Seat Height (mm)	From 450 to 520
Back Size (mm)	440W x 450H



KINETIC MID-BACK

- Popular Option



with optional 3D adjustable arms.

- Popular Option



with optional alloy star-base and arms.

Kinetic Executive

- Headrest.
- A-synchronised mechanism allows seat and back to move independently.
- Unique Push-button back height adjustment provides 80mm height range.
- Seat slide to provide more depth.
- Optional Italian designed multi-directional 3D arms.
- 10 year Aus. manufacturer warranty.

Seat Size (mm)	490W x 465D
Seat Height (mm)	From 450 to 520
Back Size (mm)	440W x 690H



KINETIC HIGH-BACK



with optional alloy star-base and arms.



Quattro

Stylish and contemporary with a square moulded foam back, the Quattro shines in any office setting, offering both comfort and good looks suitable for any commercial environment.

Certification

AFRDI Level 6 - Quattro Mid-back 3L, Quattro High-back 3L, Quattro Executive (with/without arms, & alloy-base)

POPULAR OPTIONS – See p.7 for more options

CASTORS Hard-floor, Glides,
ARMS Height Adjustable Arms
FABRIC Your choice of **any fabric**.



Quattro High-back

- 520mm back with 110mm height range.
- AFRDI Level 6 certified to severe commercial use.
- Australian made from local and imported components.
- 10 year Aus. manufacturer warranty.

Seat Size (mm)	490W x 465D
Seat Height (mm)	From 420 to 530
Back Size (mm)	450W x 520H
Certification	AFRDI Level 6



QUATTRO HIGH-BACK



with optional adjustable arms.



with optional alloy star-base.



with optional alloy star-base and arms.

Quattro Mid-back

- 460mm back with 110mm height range.
- AFRDI Level 6 certified to severe commercial use.
- Australian made from local and imported components.
- 10 year Aus. manufacturer warranty.

Seat Size (mm)	490W x 465D
Seat Height (mm)	From 420 to 530
Back Size (mm)	450W x 460H
Certification	AFRDI Level 6



QUATTRO MID-BACK



with optional adjustable arms.



with optional alloy star-base.



with optional alloy star-base and arms.

Quattro Executive

- Lockable synchronised mechanism.
- AFRDI Level 6 certified to severe commercial use.
- Australian made from local and imported components.
- 10 year Aus. manufacturer warranty.

Seat Size (mm)	490W x 465D
Seat Height (mm)	From 420 to 530
Back Size (mm)	450W x 520H
Certification	AFRDI Level 6



QUATTRO EXECUTIVE



with optional adjustable arms.



with optional alloy star-base.



with optional alloy star-base and arms.

Rexa Range

A classic for over 15 years delivering sturdy hard-working comfort – A fit for everyone. We can customise the Rexa with two back options and four seat sizes.

 MADE	10 year WARRANTY	 ANY FABRIC	120/135 kg MAX USER	2/3 lever MECH
---	--------------------------------------	---	---	------------------------------------



Certification

AFRDI Level 6 – Rexa Mid-back 2L/3L, Rexa High-back 2L/3L, Rexa Plus Mid-back 3L, Rexa Plus High-back 3L, (with/without arms, & alloy-base)

POPULAR OPTIONS – See p.7 for more options

CASTORS	60mm, Hard-floor,
GASLIFTS	Low, Intermediate
STARBASE	Polished Alloy,
ARMS	Height Adjustable Arms,
SEATS	Plus XL, Plus 2XL
FABRIC	Your choice of any fabric .

Rexa High-back

- Italian designed square look back.
- Multiple configurations are AFRDI Level 6 certified to severe commercial use.
- Standard contoured seat using Australian made moulded foam.
- 10 year Aus. manufacturer warranty.

Seat Size (mm)	490W x 465D
Seat Height (mm)	From 450 to 520
Back Size (mm)	450W x 500H
Max User	Warranted to 120kg
Certification	AFRDI Level 6



REXA HIGH-BACK

- Popular Option



with optional adjustable arms.

- Popular Option



with optional alloy star-base and arms.

Rexa Mid-back

- Italian designed square look back.
- Multiple configurations are AFRDI Level 6 certified to severe commercial use.
- Standard contoured seat using Australian made moulded foam.
- 10 year Aus. manufacturer warranty.

Seat Size (mm)	490W x 465D
Seat Height (mm)	From 450 to 520
Back Size (mm)	420W x 420H
Max User	Warranted to 120kg
Certification	AFRDI Level 6



REXA MID-BACK

- Popular Option



with optional adjustable arms.

- Popular Option



with optional alloy star-base and arms.



mesh back.

Rexa Plus

- Italian designed square look back.
- Multiple configurations are AFRDI-Level 6 certified to severe commercial use.
- Large contoured seat using Australian made moulded foam.
- 10 year Aus. manufacturer warranty.

Seat Size (mm)	520W x 490D
Seat Height (mm)	From 450 to 520
Back Size MB (mm)	420W x 420H
Back Size HB	450W x 500H
Max User	Warranted to 135kg
Certification	AFRDI Level 6



REXA PLUS MID-BACK

- Popular Option



with optional adjustable arms

- See p.17 for info on comfort duo



REXA PLUS HIGH-BACK



REXA PLUS HIGH-BACK COMFORT DUO

Team Air Range

The well known Team Air features a model for everyone & for everywhere. A stylish durable design, at a competitive price.

Certification

AFRDI Level 6 - Team Heavy-duty
Team Air Task,
AFRDI 142-Rated Load 160kg M/S
- Team Air Heavy-duty

POPULAR OPTIONS – See p.7 for more options

CASTORS Sit-lock, Hard-floor,
STARBASE Polished Hi-arch
ARMS Height Adjustable Arms,
FABRIC Your choice of **any fabric**.
Upholstered back.

 MADE	10 year WARRANTY	 ANY FABRIC	135/160 kg MAX USER	3 lever MECH	3 lever MECH	sync MECH
				Heavy-duty	Task	Meeting



Team Air Heavy-duty

- For users up to 160kg and for greater than 40 hours of use per week as certified by AFRDI 142 Rated Load.
- Super Heavy Duty Mechanism with back tilt tension control.
- Plus seat using Australian made moulded foam.

Seat Size (mm)	520W x 490D
Seat Height (mm)	From 450 to 520
Back Size (mm)	450W x 500H
Certification/ Max User	AFRDI 142-Rated Load 160kg M/S AFRDI Level 6

	- Popular Option	- Popular Option	
			
TEAM AIR HEAVY-DUTY	with optional adjustable arms.	with optional alloy star-base and arms.	with optional headrest.

Team Air Task

- Little Brother to the Team Air Heavy-duty with a standard sized seat.
- AFRDI Level 6 certified to severe commercial use.
- Standard seat using Australian made moulded foam.

Seat Size (mm)	490W x 465D
Seat Height (mm)	From 450 to 520
Back Size (mm)	450W x 500H
Max User	Warranted to 135kg
Certification	AFRDI Level 6

	- Popular Option		
			
TEAM AIR TASK	with optional adjustable arms.	with optional alloy star-base and head-rest.	CS-XPRESS – Next Day Delivery

Team Air Executive

- Designed for Meeting and Boardroom use.
- Synchronised Mechanism with back tilt adjustment.
- Plus seat using Australian made moulded foam.

Seat Size (mm)	520W x 490D
Seat Height (mm)	From 450 to 520
Back Size (mm)	450W x 500H
Max User	Warranted to 135kg

			
TEAM AIR EXECUTIVE	with optional multi-directional 3D arms.	with optional alloy star-base and multi-directional 3D arms.	with optional headrest.



OFFICE
EASY
HARDWORK

your
never
learning

Utility Drafting

Chair Solutions have an extensive range of technical height chairs. Offering full ergonomic and adjustable features.

Certification

AFRDI Level 6 - Lab Tech Chair
Geca Certified - Apollo Drafter
Lab 300 Tech Chair

POPULAR OPTIONS – See p.7 for more options

CASTORS Glides, Lockable, Hard-floor,
STARBASE Polished alloy
ARMS Height Adjustable Arms,
FABRIC Your choice of **any fabric**.
Healthcare grade vinyl.



Utility Drafting

- Adjustable height foot-ring.
- Made in Australia from local and imported components.
- 10 year Aus. manufacturer warranty.

Seat Size (mm)

Alpha Drafter	480W x 450D
Apollo Drafter	490W x 465D
Delta Drafter	490W x 465D
Delta Mesh Drafter	490W x 465D
Rexa Drafter	490W x 465D
Rexa Mesh Drafter	490W x 465D
Team Air Drafter	490W x 465D

Seat Height (mm)

Alpha Drafter	590 to 840
Apollo Drafter	590 to 840
Delta Drafter	590 to 840
Delta Mesh Drafter	590 to 840
Rexa Drafter	590 to 840
Rexa Mesh Drafter	590 to 840
Team Air Drafter	660 to 910

Certification

AFRDI Level 6
– Lab Tech Chair



ALPHA-LOGIC DRAFTER



APOLLO DRAFTER



DELTA DRAFTER



DELTA MESH DRAFTER



REXA DRAFTER



REXA MESH DRAFTER



TEAM AIR DRAFTER

Utility Stools

- 400mm diameter round.
- Made in Australia from local and imported components.
- 10 year Aus. manufacturer warranty.

Alpha Seat Size

400 diameter

Perching Seat Size

490W x 465D

Seat Height (mm)

Alpha Stool	450 to 520
Alpha Tech Stool	590 to 840
Perching Stool	590 to 840



ALPHA TECH STOOL



ALPHA STOOL



PERCHING STOOL



Utility Lab

- Non-slip polyurethane seat and back
- Steel sub-frame
- Italian design.
- Made in Australia from local and imported components.
- 10 year Aus. manufacturer warranty.

Lab 100 Seat Size 350 diameter
Seat Height (mm) From 450 to 520

Lab 200 Seat Size 340W x 260D
Seat Height (mm) From 590 to 840

Lab 300 size (mm) 450W x 500H
Seat Height From 590 to 840



LAB 100
STOOL



LAB 200
CHAIR



LAB 300
TECH CHAIR



LAB 300 TECH
CHAIR AFRDI
CERTIFIED

Why

Designed by Roger and Webb Associates in Europe, Based on a reactive, synchronised mechanism, which is simple and intuitive to operate, Why has a height adjustable, unique contoured backrest, moulded from a high performance polymer that flexes and adjusts to the movement of the body.



Why

- Contoured back ensures pelvic and lumbar support.
- Why has been designed to minimise the number of components used in construction and is 98% recyclable.
- 10 year Aus. Manufacturing warranty.

Seat Size (mm)	500W x 500D
Seat Height (mm)	From 450 to 520
Back Size (mm)	450W x 520H

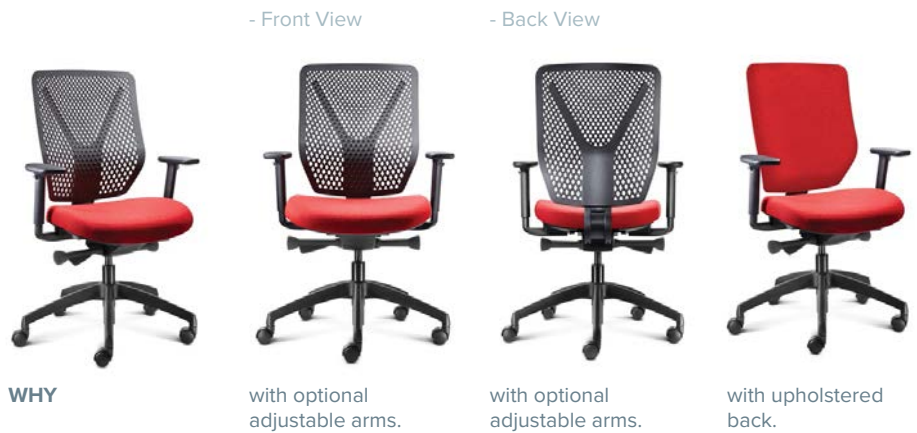



Ascend Sit-stand

Modern offices and jobs have forced people to spend far longer sitting down than standing up. This has serious consequences for the health of individuals, the posture of many people, and ultimately our lifespan.



Ascend Desk

- Twin motor providing 180kg heavy duty lift capacity.
- Quick and quiet adjustment speed.
- Supports tops ranging from 1300 to 2000mm wide, and 600 to 900mm deep.
- 3 Programmable memory pre-sets.
- Anti-collision.



**ASCEND DESK
WHITE**



**ASCEND DESK
BLACK**

Desk Width (mm)	1300 to 2000
Desk Height (mm)	620 to 1270

Ascend Workstation

- Workstation (corner) provides a 270kg heavy duty lift capacity.
- Quick and quiet adjustment speed.
- Supports tops ranging from 1300 to 2000mm wide and 800mm deep.



**ASCEND WORKSTATION
WHITE**



**ASCEND WORKSTATION
BLACK**

Desk Width (mm)	1300 to 2000
Desk Height (mm)	620 to 1270

Ascend Back to Back

- Each desk provides 180kg of heavy duty lift capacity.
- Quick and quiet adjustment speed.
- Supports tops ranging from 1300 to 2000mm wide and 800mm deep.



**ASCEND BACK TO
BACK WHITE**



**ASCEND BACK TO
BACK BLACK**

Desk Width (mm)	1300 to 2000
Desk Height (mm)	620 to 1270



Visitor

CS One

36

Design

37

Jubel

38-39

Oxygen

40-41

Reload

42-43

Venice Range

44-45

Zen

46-47

Flite Beam Seating

74

Features / Icons

5/10
year
WARRANTY

WARRANTY

Replace or repair on all chair components.* Excludes fabric.



MADE

AU MADE

These products are proudly upholstered and assembled locally in Australia.

10
high
STACKS

STACKS

These chairs can stack up to its specified amount.

140
kg
MAX USER

MAX USER RATING

Chair Solutions recommends these products for users up to its max user weight. These products are supported by our warranty policy.



ANY FABRIC

ANY FABRIC

Chair is upholstered in any fabric of your choice.



Certification



AFRDI

Most certified fixed height chairs in Australia and NZ are tested to the requirements of AS/NZS 4438:1997 - Height adjustable swivel chairs. AFRDI level 6 standard is regarded as appropriate for people up to about 100kg.

AFRDI Level 6

An AFRDI Level 6 certified fixed height chair will meet most commercial needs. Level 6 chairs are described as suitable for "extremely heavy conditions" in the standard.



GECA

Australia's trusted eco-label for planet and people.

Good Environmental Choice Australia empowers architects, builders, designers and consumers to have confidence in their purchasing decisions, and trust GECA certified products to be healthier, safer, and better for the environment.

ChairSolutions offer a range of GECA certified products

CS One

The CS One consists of the highest levels of seating comfort with exemplary simple design. This linking and stacking chair is perfectly suited to large spaces.

OPTIONS

BASES 4 leg, castors, sled, barstool
 SHELL Black, white, red or blue
 FABRIC Your choice of any fabric.

COLOUR OPTIONS



CS One 4 leg

- Stacks 39 high on a trolley.
- High density steel and plastic.
- 5 year Aus. manufacturing warranty.

Seat Size (mm)	450W x 420D
Seat Height (mm)	450
Back Size (mm)	450W x 400H
Stacks	10 high or 39 high on trolley



CS ONE
4 LEG

with seat pad.

with optional castors.

optional red shell.

CS One Sled

- Linking device to create rows.
- Stacks 39 high on a trolley.
- High density steel and plastic.
- 5 year Aus. manufacturing warranty.

Seat Size (mm)	450W x 420D
Seat Height (mm)	450
Back Size (mm)	450W x 400H
Stacks	10 high or 39 high on trolley



CS ONE
SLED

with seat pad.

optional blue shell.

optional trolley
(Stacks 39 high)

CS One Barstool

- Footrest for added comfort and stability.
- High density steel and plastic.
- 5 year Aus. manufacturing warranty.

Seat Size (mm)	450W x 420D
Seat Height (mm)	780
Back Size (mm)	450W x 400H



CS ONE
BARSTOOL

with seat pad.

optional blue shell.

optional red shell.

Design

The Design range showcases sleek, slimline styling in a practical stacking chair. Suitable for both commercial and residential use.

OPTIONS

BASES Sled, cantilever four or five star with castors
FABRIC Your choice of any fabric.

 MADE	 ANY FABRIC	 5 year WARRANTY	 120 kg MAX USER	 4 high STACKS
---	---	---	---	---

Design Sled

- Stainless steel frame.
- Sled stacks 4 high.
- 5 year Aus. manufacturing warranty.

Seat Size (mm)	480W x 420D
Seat Height Sled	465
Seat Height Castors	485
Back Size (mm)	460W x 400H
Sled Stacks	4 high



DESIGN SLED

DESIGN 4 POINT WITH CASTORS

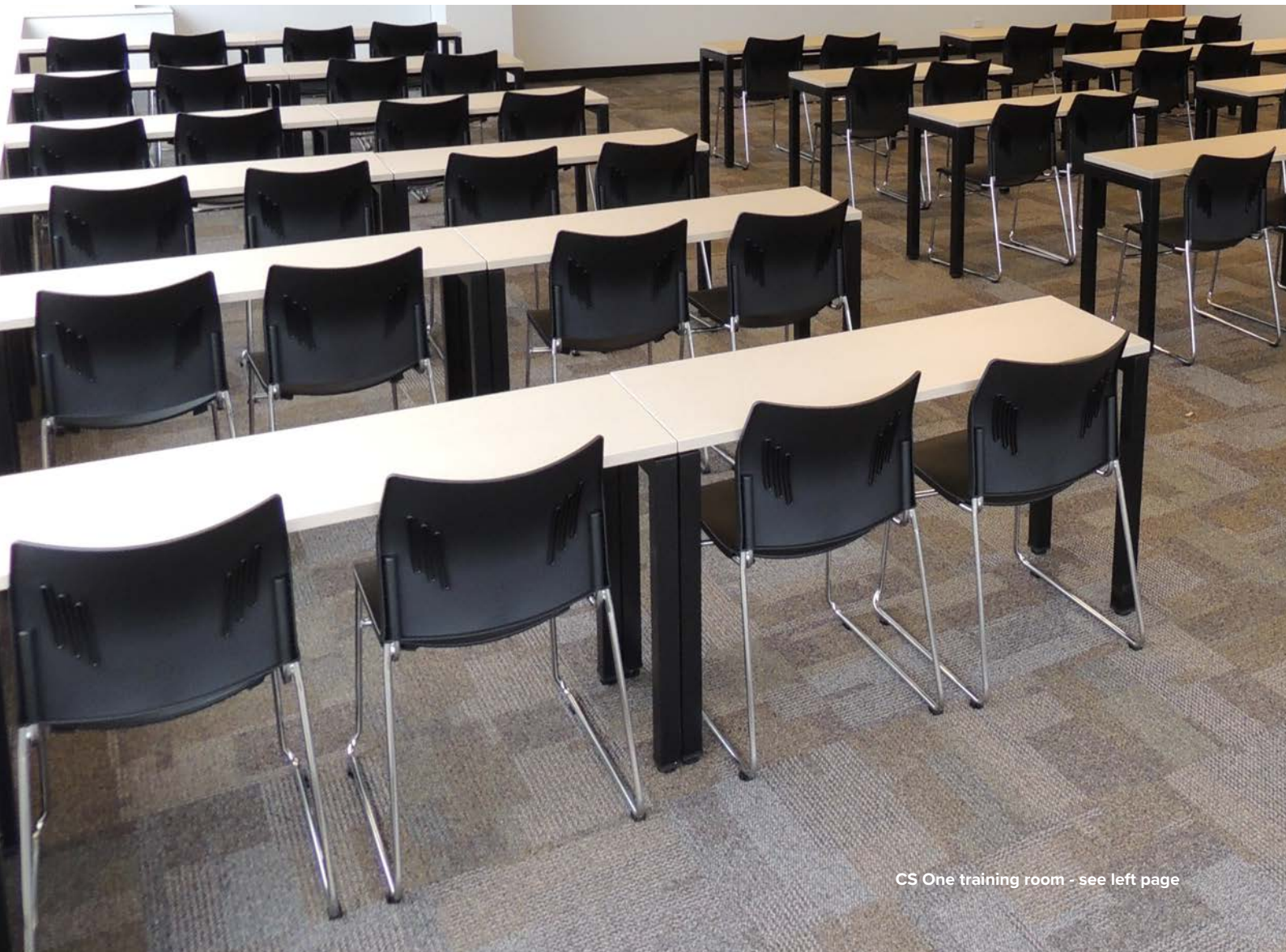

Jubel

Jubel's compact dimensions make it ideal for high density applications such as training, conference auditoriums and educational purposes. Its fresh modern profile is also attractive in a retail setting.

 MADE	 ANY FABRIC	 5 year WARRANTY	 120 kg MAX USER	 4 high STACKS
---	---	---	---	---

POPULAR OPTIONS

BASES 4 leg in chrome, white, black or timber
Sled in chrome, white or black
Castors in chrome or black
Barstool in black sled only

SHELL FABRIC Black, white, grey or sand
Your choice of **any fabric**.

COLOUR OPTIONS

Black	White	Grey	Sand
-------	-------	------	------

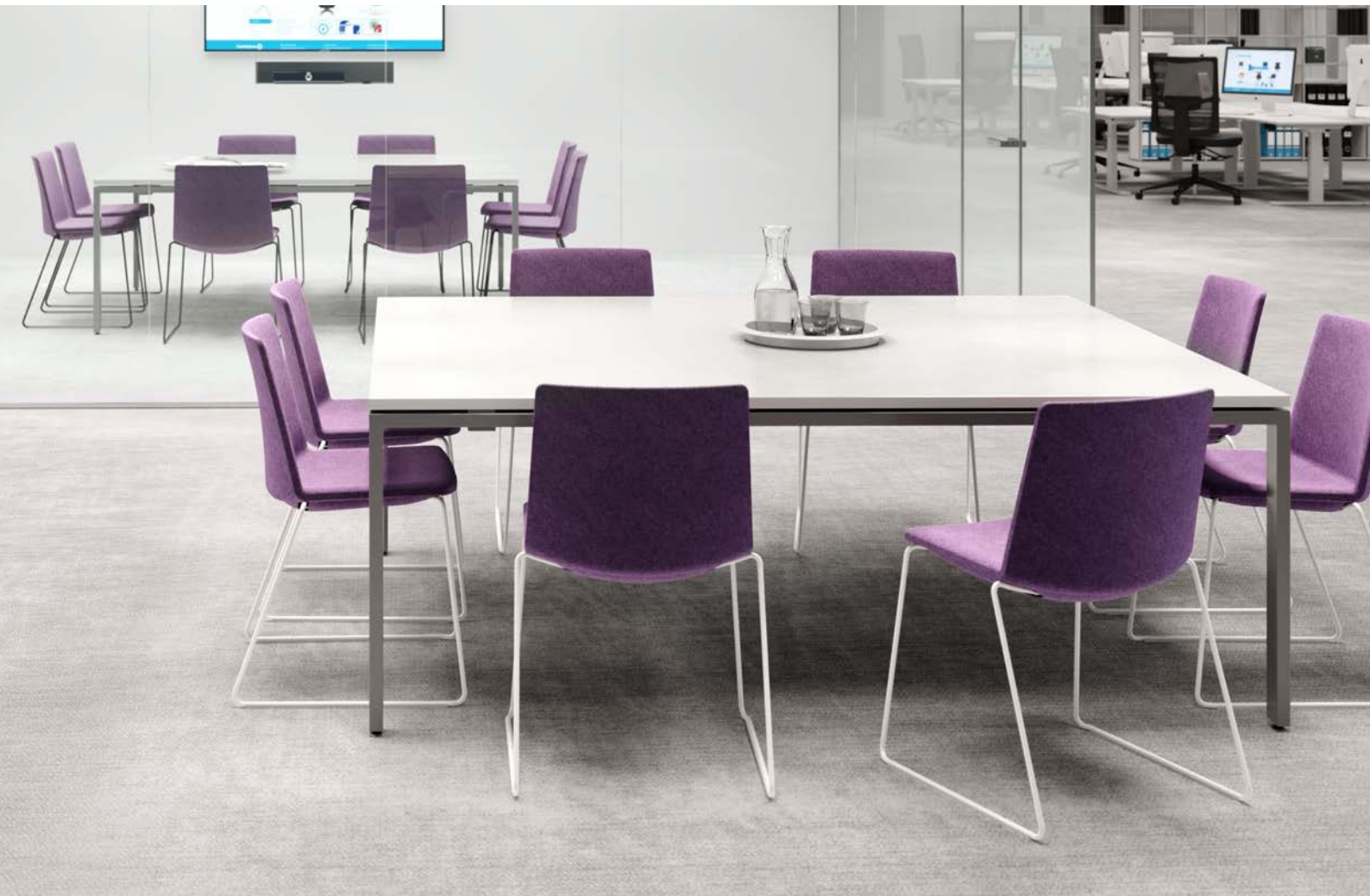

Jubel Sled

- Italian designed.
- Lightweight and stackable to 4 high.
- Gentle controlled flex back.
- 5 year Aus. manufacturer warranty.

Seat Size (mm)	440W x 430D
Seat Height (mm)	450
Back Size (mm)	440W x 400H
Stacks	4 high



JUBEL SLED



with seat pad.



fully upholstered.



fully upholstered with stitching detail.

Jubel 4 leg

- Italian designed.
- Lightweight and stackable to 4 high.
- Gentle controlled flex back.
- 5 year Aus. manufacturer warranty.

Seat Size (mm) 440W x 430D

Seat Height (mm) 450

Back Size (mm) 440W x 400H

Stacks 4 high



**JUBEL
4 LEG**



with seat pad.



fully upholstered.



fully upholstered
with stitching detail.

Jubel Castors

- Italian designed.
- Optional arm.
- Height adjustable gas lift.
- Gentle controlled flex back.
- 5 year Aus. manufacturer warranty.

Seat Size (mm) 440W x 430D

Seat Height (mm) From 450 to 520

Back Size (mm) 440W x 400H



**JUBEL
CASTORS**



with seat pad.



fully upholstered.



fully upholstered
with stitching detail
and optional arm.

Jubel Timber

- Italian designed.
- Gentle controlled flex back.
- 5 year Aus. manufacturer warranty.

Seat Size (mm) 440W x 430D

Seat Height (mm) 450

Back Size (mm) 440W x 400H



**JUBEL
TIMBER**



with seat pad.



fully upholstered.



fully upholstered
with stitching detail.

Jubel Barstool

- Footrest for added comfort and stability.
- Italian designed.
- Gentle controlled flex back.
- 5 year Aus. manufacturer warranty.

Seat Size (mm) 440W x 430D

Seat Height (mm) 760

Back Size (mm) 440W x 400H



**JUBEL
BARSTOOL**



with seat pad.



fully upholstered.



fully upholstered
with stitching detail.

Oxygen

Italian designed visitor chair, built in Australia for the places we gather. Oxygen keeps people connected.

CERTIFICATION

Independently tested by Catas
EN 16139:2013, level L2 - extreme
See website for further details

POPULAR OPTIONS

BASE Black or white powdercoat
SHELL Black, grey, white or red
FABRIC Your choice of **any fabric**.



COLOUR OPTIONS



Oxygen

- 100% recyclable polypropylene injection.
- Stacks 39 on a trolley.
- 5 Year Aus. Manufacturer Warranty.

Seat Size (mm)	450W x 500D
Seat Height (mm)	450
Back Size (mm)	440W x 400H
Stacks	10 high or 39 high on a trolley



OXYGEN



grey shell.



with seat pad.

Oxygen Mesh

- 100% recyclable polypropylene injection.
- Stacks 39 on a trolley.
- 5 Year Aus. Manufacturer Warranty.

Seat Size (mm)	450W x 500D
Seat Height (mm)	450
Back Size (mm)	440W x 400H
Stacks	10 high or 39 high on a trolley



OXYGEN MESH



with seat pad.

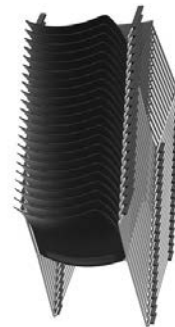





Reload

The Reload collection is extremely functional and interchangeable. Designed in Italy by Jeremiah Ferrarese and Paolo Scagnellato, it is the evolution in economical conference, waiting and visitor seating.

POPULAR OPTIONS

BASE	Black 4 leg
FABRIC	Your choice of any fabric .
ARM	Tablet arm
BEAM	Beam option available

 MADE	 ANY FABRIC	5 year WARRANTY	120 kg MAX USER	15 high STACKS
---	---	-------------------------------------	-------------------------------------	------------------------------------

Reload

- Linking device to create rows.
- Stacks vertically with no contact between the seats.
- Italian designed.
- 5 year Aus. manufacturing warranty.
- Tablet arm option available.

Seat Size (mm)	460W x 450D
Seat Height (mm)	420
Back Size (mm)	460W x 340H
Stacks	15 high



RELOAD

with seat pad.

fully upholstered.

Reload Mesh

- Linking device to create rows.
- Stacks vertically with no contact between the seats.
- Italian designed.
- 5 year Aus. manufacturing warranty.
- Tablet arm option available.

Seat Size (mm)	460W x 450D
Seat Height (mm)	420
Back Size (mm)	460W x 340H
Stacks	15 high



RELOAD MESH

with seat pad.

Reload Beam

- Italian designed.
- Benches are customisable to your desired seating configuration.
- 5 year Aus. manufacturing warranty.



RELOAD BEAM
customisable configuration

Venice Range

The Venice Range is a durable comfortable option and the best choice for long term seating. The versatility of the linea, the modern mesh and the timeless round back, means there is a visitor range that will compliment every environment.

 MADE	 ANY FABRIC	5 year WARRANTY	135 kg MAX USER	4 high STACKS		
---	---	------------------------------	------------------------------	----------------------------	---	---



Venice Linea

- AFRDI Level 6 - Certified to Severe Commercial Use.
- Seat and back using Australian made moulded foam.
- Stacks 4 high on the ground.

Seat Size (mm)	460W x 460D
Seat Height (mm)	460
Back Size (mm)	460W x 400H
Stacks	4



VENICE LINEA



with black legs and arms.



with black sled.



with chrome sled and arms.

POPULAR OPTIONS

BACKS	Upholstered, mesh or round
BASE	4 leg or sled in black or chrome
ARMS	Optional arms - square or round
FABRIC	Your choice of any fabric .

Venice Mesh

- AFRDI Level 6 - Certified to Severe Commercial Use.
- Seat using Australian made moulded foam.
- Stacks 4 high on the ground.

Seat Size (mm)	460W x 460D
Seat Height (mm)	460
Back Size (mm)	460W x 400H
Stacks	4



VENICE MESH



with black legs and arms.



with black sled.



with chrome sled and arms.

Venice Round

- AFRDI Level 6 - Certified to Severe Commercial Use.
- Seat and back using Australian made moulded foam.
- Stacks 4 high on the ground.

Seat Size (mm)	460W x 460D
Seat Height (mm)	460
Back Size (mm)	460W x 400H
Stacks	4



VENICE ROUND



with black legs and arms.



with black sled.



with chrome sled and arms.

Venice Utility

Additional to our Venice Range, we offer a tall leg option and a larger Bariatric heavy duty chair with a load bearing capacity of 226kg. For use in healthcare and aged care environments.

Bariatric Seat Size	760W x 460D
Back Size (mm)	760W x 410H
Seat Height (mm)	445
Venice Seat Height	510



VENICE LINEA TALL LEG



Mesh back with arms.



BARIATRIC

Zen

The Zen offers comfort, colour and modern seating with an Italian designed edge. Featuring an ergonomically contoured seat with a flexible polypropylene shell, available in 8 colours, it is suitable for many applications.

 MADE	 ANY FABRIC	 5 year WARRANTY	 120 kg MAX USER	 8 high STACKS
---	---	---	---	---

POPULAR OPTIONS

BASES	4 leg, sled, timber, castors, stool 4 star, 5 star & beam configurations
SHELL	Black, white, green, red, orange, grey, sand, blue or fully upholstered
FABRIC	Your choice of any fabric .

COLOUR OPTIONS

Orange	Red	Green	Black
White	Sand	Grey	Blue

Zen Four Leg & Barstool

- Flexible polypropylene shell.
- Self-levelling feet.
- Italian designed.
- 5 Year Aus. Manufacturer Warranty.
- Stacks 8 high on the ground.

Seat Size (mm)	440W x 440D
Seat Height (mm)	450
Stool Seat Height	780
Stacks	8 high

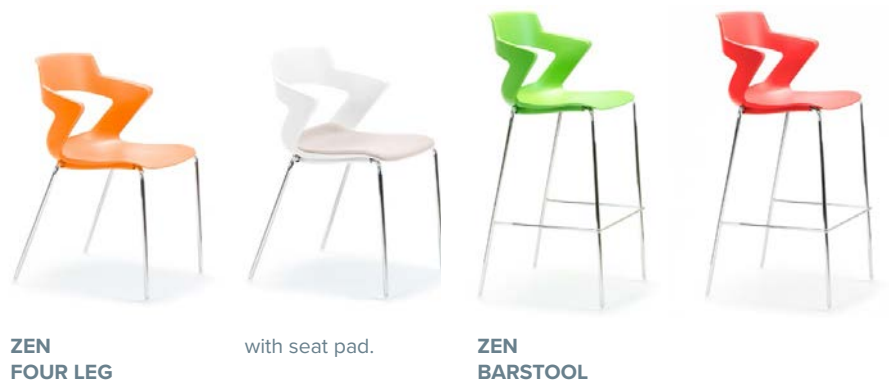

Zen Timber

- Flexible polypropylene shell.
- Raw timber frame.
- Italian designed.
- 5 Year Aus. Manufacturer Warranty.

Seat Size (mm)	440W x 440D
Seat Height	450
Back Size (mm)	440W x 400H

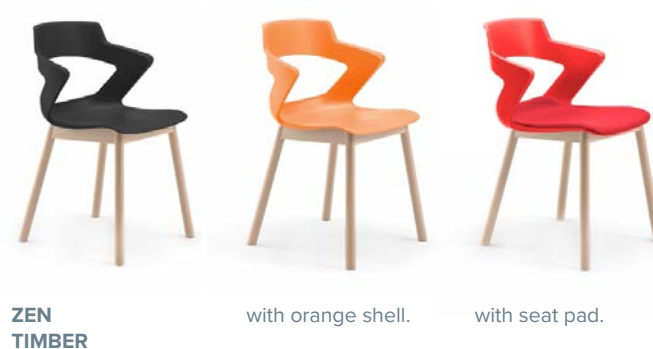

Zen Castors

- Flexible polypropylene shell.
- Height adjustable gaslift.
- Italian designed.
- 5 Year Aus. Manufacturer Warranty.

Seat Size (mm)	440W x 440D
Seat Height (mm)	From 450 to 520
Back Size (mm)	440W x 400H





Zen Sled & Four Point

- Flexible polypropylene shell.
- Full length glides on sled to protect floor surfaces.
- Italian designed.
- 5 Year Aus. Manufacturer Warranty.
- Stacks 8 high on the ground.

Seat Size (mm)	440W x 440D
Seat Height (mm)	450
Back Size (mm)	440W x 400H
Sled Stacks	8 high



**ZEN
SLED**



with seat pad.



fully upholstered.



**ZEN
FOUR POINT**

Soft Seating

Billabong

50

Chi & Chill

51

Drop Lounge & Highway

52-53

Koo, Koosh & Lulu

54-55

Malibu

56-57

Ottomans

58-59

Quartz & Quiet Round

60-61

Quiet Lounges & Workday

62-63



Adele & Annette

64-65

Camilla & Marcela

66-67

Paris & Prestige

68

Sixty & Queen

69

Zelig

70-71

Zorb Acoustics

72-73

CS Soft Seating + Ottoman Base Options



Chrome Legs
– Chrome Round
4 legs 150mm (H)



Aluminum Legs
– BOSARI Brushed
aluminum, 4 legs
150mm (H)



Black Leg
– BOSARI Black
Nickel 4 legs
150mm (H)



Timber Round Leg
– Round taper
Timber 4 legs
180mm (H)

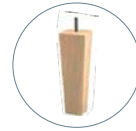

Timber Square Leg
– Square taper
Timber 4 legs
180mm (H)



Single Lounge
Stainless steel 4 legs



Double Lounge
Stainless steel 4 legs



Triple Lounge
Stainless steel 4 legs



**Stainless steel
sled**



Our CS “by-Rossetto” brand-mark identifies our genuine Italian designed, cold-cure moulded, commercial soft seating – upholstered by expert upholsterers in our CS factories throughout Australia and New Zealand.



Traditional seating products
Wooden frame + cut foam made

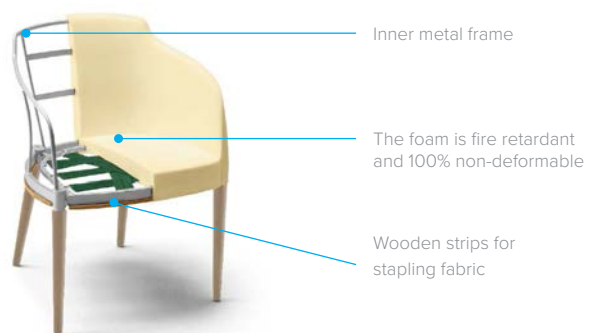

“By Rossetto” moulded polyurethane products
Metal frame + cold cure moulding

Billabong

Designed to fit in anywhere without crowding the space. Billabong brings a casual charm to the workplace. Its simple, adaptable design makes it easy to reconfigure.

POPULAR OPTIONS – See p.49 for more options

SEAT SIZES 1 or 2 seater
FABRIC Your choice of **any fabric**.



Billabong *Single Seater*



Seat Size (mm)	840W x 750D
Seat Height (mm)	450
Overall Size (mm)	750H

**BILLABONG
SINGLE SEATER.**

Billabong *Two Seater*



Seat Size (mm)	1680W x 750D
Seat Height (mm)	450
Overall Size (mm)	750H

**BILLABONG
TWO SEATER.**

Chi & Chill

Add an aesthetic touch to your office waiting room with the contemporary Chi & Chill range. 100% Australian made, the Chi & Chill features locally sourced Australian timber accompanied with top Australian high quality foams.

POPULAR OPTIONS – See p.49 for more options

SEAT SIZES 1, 2 or 3 seater
 ARMS With or without arms
 FABRIC Your choice of **any fabric**.



Chi & Chill Single Seater

Seat Size (mm)	560W x 450D
Seat Height (mm)	450
Overall Size (mm)	560W x 700D x 800H
Overall Size arms	760W x 700D x 800H
Arm Height (mm)	620



**CHI
SINGLE SEATER**



**CHILL
SINGLE SEATER**

SOFT

Chi & Chill Two Seater

Seat Size (mm)	1070W x 450D
Seat Height (mm)	450
Overall Size (mm)	1070W x 700D x 800H
Overall Size arms	1270W x 700D x 800H
Arm Height (mm)	620



**CHI
TWO SEATER**



**CHILL
TWO SEATER**

Chi & Chill Three Seater

Seat Size (mm)	1515W x 700D
Seat Height (mm)	450
Overall Size (mm)	1515W x 700D x 800H
Overall Size arms	1715W x 700D x 800H
Arm Height (mm)	620



**CHI
THREE SEATER**



**CHILL
THREE SEATER**

Drop Lounge

Australian made casual commercial seating. Designed with down sloping arms and a squared-off top of back. High Density Foam set. Available in 1, 2 or 3 seat versions with fixed cushioning.

POPULAR OPTIONS – See p.49 for more options

SEAT SIZES 1, 2 or 3 seater
FABRIC Your choice of **any fabric**.



Drop Lounge *Single Seater*

Seat Size (mm)	620W x 480D
Seat Height (mm)	430
Overall Size	920W x 760D x 700H
Arm Height (mm)	620



**DROP LOUNGE
SINGLE SEATER**



with sled base.

Drop Lounge *Two Seater*

Seat Size (mm)	1200W x 480D
Seat Height (mm)	430
Overall Size	1500W x 760D x 700H
Arm Height (mm)	620



**DROP LOUNGE
TWO SEATER**



with sled base.

Drop Lounge *Three Seater*

Seat Size (mm)	1720W x 480D
Seat Height (mm)	430
Overall Size	2020W x 760D x 700H
Arm Height (mm)	620



**DROP LOUNGE
THREE SEATER**



with sled base.

Highway

The Australian made Highway features a unique modern timber frame, and upholstered in your choice of fabric.

POPULAR OPTIONS

SEAT SIZES 1, 2 or 3 seater
FABRIC Your choice of **any fabric**.
FINISHES Natural or dark stained timber



Highway *Single Seater*



Seat Size (mm)	570W x 750D
Overall Size (mm)	570W x 850D
Seat Height (mm)	450
Overall Height	750

**HIGHWAY
SINGLE SEATER**

Highway *Two Seater*



Seat Size (mm)	1200W x 750D
Overall Size (mm)	1200W x 850D
Seat Height (mm)	450
Overall Size	750

**HIGHWAY
TWO SEATER**

Highway *Three Seater*



Seat Size (mm)	1800W x 750D
Overall Size (mm)	1800W x 850D
Seat Height (mm)	450
Overall Size	750

**HIGHWAY
THREE SEATER**

Similar product
Malibu – Page 56

Koo & Koosh

Add a contemporary touch to your office or waiting room with the Koo and Koosh. They are Australian made using Australian timber, Dunlop foams and Australian workmanship. Available in one, two and three seater configurations.

POPULAR OPTIONS – See p.49 for more options

SEAT SIZES 1, 2 or 3 seater
 ARMS With or without arms
 FABRIC Your choice of **any fabric**.



Koo & Koosh Single Seater

Seat Size (mm)	560W x 450D
Seat Height (mm)	450
Overall Size	560W x 700D x 800H
Overall Size Arms	760W x 700D x 800H
Arm Height (mm)	620



**KOO
SINGLE SEATER**



**KOOSH
SINGLE SEATER**

Koo & Koosh Two Seater

Seat Size (mm)	1070W x 450D
Seat Height (mm)	450
Overall Size	1070W x 700D x 800H
Overall Size Arms	1270W x 700D x 800H
Arm Height (mm)	620



**KOO
TWO SEATER**



**KOOSH
TWO SEATER**

Koo & Koosh Three Seater

Seat Size (mm)	1515W x 450D
Seat Height (mm)	450
Overall Size	1515W x 700D x 800H
Overall Size Arms	1715W x 700D x 800H
Arm Height (mm)	620



**KOO
THREE SEATER**



**KOOSH
THREE SEATER**

Lulu

Australian made casual commercial seating. Designed with arms and loose cushions. High Density Foam set. Available in 1, 2 or 3 seat version with round chrome look legs.

POPULAR OPTIONS – See p.49 for more options

SEAT SIZES 1, 2 or 3 seater
FABRIC Your choice of any fabric.



Lulu Single Seater



Seat Size (mm)	620W x 480D
Seat Height (mm)	430
Overall Size	920W x 760D x 700H
Arm Height (mm)	620

LULU
SINGLE SEATER

Lulu Two Seater



Seat Size (mm)	1200W x 480D
Seat Height (mm)	430
Overall Size	1500W x 760D x 700H
Arm Height (mm)	620

LULU
TWO SEATER

Lulu Three Seater



Seat Size (mm)	1720W x 480D
Seat Height (mm)	430
Overall Size	2020W x 760D x 700H
Arm Height (mm)	620

LULU
THREE SEATER

Malibu

The Australian made Malibu features a unique modern timber frame, and upholstered in your choice of fabric.

POPULAR OPTIONS

SEAT SIZES 1 or 2 seater
FABRIC Your choice of **any fabric**
FINISHES Natural or dark stained timber



Malibu *Single Seater*

Seat Size (mm)	570W x 550D
Overall Size (mm)	750W x 800D x 810H
Seat Height (mm)	450
Arm Height	600



**MALIBU
SINGLE SEATER**



with dark stained timber.

Malibu *Two Seater*

Seat Size (mm)	1200W x 550D
Overall Size (mm)	1380W x 800D x 810H
Seat Height (mm)	450
Arm Height	600



**MALIBU
TWO SEATER**

dark stained timber available.

See also
Highway – Page 53



SOFIT

Ottomans

Versatile, contemporary and multi-functional. An Ottoman is a great addition to any office, educational institute, breakout and informal area. Limited by your imagination, shapes and size options are almost endless.

POPULAR OPTIONS – See p.49 for more options

FABRIC
BASES

Your choice of **any fabric**.
Standard with plastic glides



Straight Ottomans

Stay Cube (mm)	450 x 450
Box (mm)	600 x 600w 1200W x 450D 1500W x 600D 1800W x 600D 2100W x 600D 1800W x 750D
Seat Heights (mm)	450



STAY (CUBE)



BOX

Pebble Ottomans

Pebble (mm)	450, 600, 900 or 1200 diameters
Seat Heights (mm)	450



PEBBLE
600



PEBBLE
1200

Rounded Ottomans

Drum (mm)	450 diameter
Round (mm)	600 or 900 diameter
Robot	500, 750 or 900
Seat Heights (mm)	450



SIT (DRUM)



ROUND



ROBOT

Curved Ottomans

Cut Snake (mm)	1280W x 450D
Wave (mm)	1500L x 600D
Seat Heights (mm)	450



CUT SNAKE



WAVE

Triangular Ottomans

Pie (mm)	485 diameter
Triangle (mm)	600 diameter
Pebble (mm)	450, 600, 900 or 1200 diameters
Seat Heights (mm)	450



PIE



TRIANGLE



PEBBLE

Clover	850 diameter
Seat Height (mm)	450

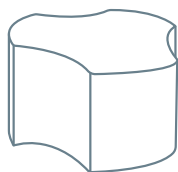

CLOVER

Quartz

The contemporary square lines make the ever popular Quartz lounge stand out in any modern office. Made to order in any fabric using Australian timber and high density foams, including legs with adjustable feet.

POPULAR OPTIONS – See p.49 for more options

SEAT SIZES 1, 2 or 3 seater
FABRIC Your choice of any fabric.



Quartz Single Seater



Seat Size (mm)	620W x 480D
Seat Height (mm)	430
Overall Size (mm)	920W x 760D x 700H
Arm Height (mm)	620

QUARTZ
SINGLE SEATER

Quartz Two Seater



Seat Size (mm)	1200W x 480D
Seat Height (mm)	430
Overall Size (mm)	1500W x 760D x 700H
Arm Height (mm)	620

QUARTZ
TWO SEATER

Quartz Three Seater



Seat Size (mm)	1500W x 480D
Seat Height (mm)	430
Overall Size (mm)	2020W x 760D x 700H
Arm Height (mm)	620

QUARTZ
THREE SEATER

Quiet Round

Each piece is 1/6th of a complete circle. Purchase individual pieces or multiple pieces. Use 5 to create an enclosed collaborative workspace.

POPULAR OPTIONS – See p.49 for more options

SIZES Low back or high back
 FABRIC Your choice of **any fabric**.



High-back

Seat Size Single (mm)	450W x 500D
High Back Boarder	250W x 1107H
Seat Height (mm)	450
Outer Diameter (mm)	3200



QUIET ROUND HIGH BACK SINGLE

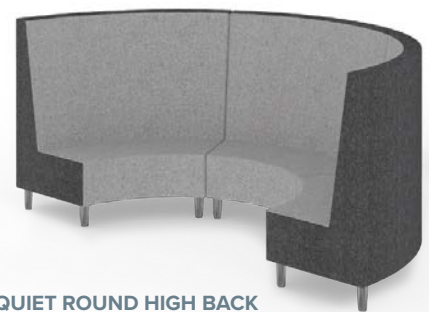

QUIET ROUND HIGH BACK THREE PIECE (HALF CIRCLE)

Low-back

Seat Size (mm)	450W x 500D
Low Back Boarder	250W x 632H
Seat Height (mm)	450
Outer Diameter (mm)	3200



QUIET ROUND LOW BACK SINGLE

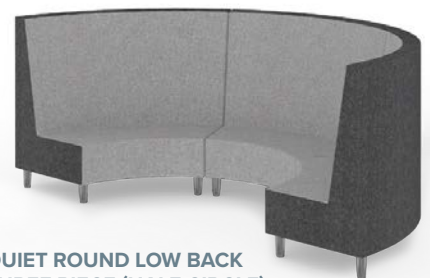

QUIET ROUND LOW BACK THREE PIECE (HALF CIRCLE)

SOFT

Quiet Lounges

With acoustic qualities, these high back lounges are perfect for any breakout area where privacy is a must. Used for meeting or quiet time. Australian made with high density foams.

POPULAR OPTIONS – See p.49 for more options

SEAT SIZES 1, 2 or 3 seater
FABRIC Your choice of **any fabric**.



Quiet Lounge *Single Seater*

Seat Size (mm)	650W x 500D
Overall Size - Arms	900W x 750D x 1350H
Seat Height (mm)	450



QUIET LOUNGE
single seater.



WING
single seater.

Quiet Lounge *Two Seater*

Seat Size (mm)	1250W x 500D
Overall Size - Arms	1500W x 750D x 1350H
Seat Height (mm)	450



QUIET LOUNGE
two seater.



WING
two seater.

Quiet Lounge *Three Seater*

Seat Size (mm)	1750W x 500D
Overall Size - Arms	2000W x 750D x 1350H
Seat Height (mm)	450



QUIET LOUNGE
three seater.



WING
three seater.

Workday

With the need for break out and meeting areas in modern work spaces, libraries and institutions, the Workday is the natural choice.

POPULAR OPTIONS – See p.49 for more options

SEAT SIZES Single seater
FABRIC Your choice of **any fabric**.



Workday *Single Seater*

Seat Size (mm)	620W x 480D
Seat Height (mm)	430
Overall Size	920W x 760D x 700H



SOFT



Adele

Stylish Italian made and designed by Rossetto. Featuring a flexible back and available in 2 base options, upholstered in the fabric of your choice.

POPULAR OPTIONS

BASES	GC - Polished inox legs GL - wooden legs
FINISHES	Dark or Natural stained timber, Polished inox
FABRIC	Your choice of any fabric .



Adele

Overall Size (mm)	500W x 680D x 790H
Seat Size (mm)	500W x 450D
Seat Height	460
Arm Height (mm)	650



GC polished inox legs



GL stained or raw wooden legs

Annette

Stylish mid back, Italian made and designed by Rossetto. Available in 5 different base options and upholstered in the fabric of your choice.

POPULAR OPTIONS

BASES	L5 - 4 leg timber L7 - 4 leg timber P10 - chrome swivelling base D1 - steel swivelling Castors
FINISHES	Dark or Natural stained timber Polished chrome
FABRIC	Your choice of any fabric . Two tone, separate seat pad



ROSSETTO

Annette

Overall Size (mm)	520W x 600D x 790H
Seat Size (mm)	500W x 450D
Seat Height	460
Arm Height (mm)	610



L5 natural or dark stained timber legs.



L7 natural or dark stained timber legs.



P10 polished chrome metal, swivelling.



D1 polished steel swivelling.



with castor's.

Camilla

Simple modern square design, offering great comfort and look. A perfect piece in an architecturally designed space through its minimal and simple structure.

POPULAR OPTIONS

BASES	L8 - 4 leg timber S6 - chrome sled base R14 - 4 star polished base
FINISHES	Natural timber
FABRIC	Your choice of any fabric .



Camilla

Overall Size (mm)	740W x 680D
Overall Height (mm)	770
Seat Size (mm)	740W x 510D
Seat Height (mm)	400



L8 natural timber base.



S6 chrome sled base.



R14 4 star swivelling base.

Marcela

Elegant Italian design, an ideal look for any office or waiting area. Utilising strong steel frame-work, and entirely moulded in cold-cure polyurethane.

POPULAR OPTIONS

BASES
FABRIC

Dark or natural stained timber
Your choice of **any fabric**.



ROSSETTO

Marcela

Overall Size (mm)	590W x 570D x 780H
Seat Size (mm)	480W x 440D
Seat Height (mm)	460
Arm Height (mm)	660



Natural timber leg.

Dark stained timber leg.

Paris & Prestige

Sophisticated Italian design with sharp lines. Available in 3 base options, utilising strong steel frame-work, and entirely moulded in cold-cure polyurethane.

POPULAR OPTIONS

BASES	D7 - steel swivelling base R13 - chrome swivelling L10 - 4 leg timber (Paris) L21 - 4 leg timber (Prestige)
FINISHES	Dark or Natural stained timber Polished chrome
FABRIC	Your choice of any fabric .

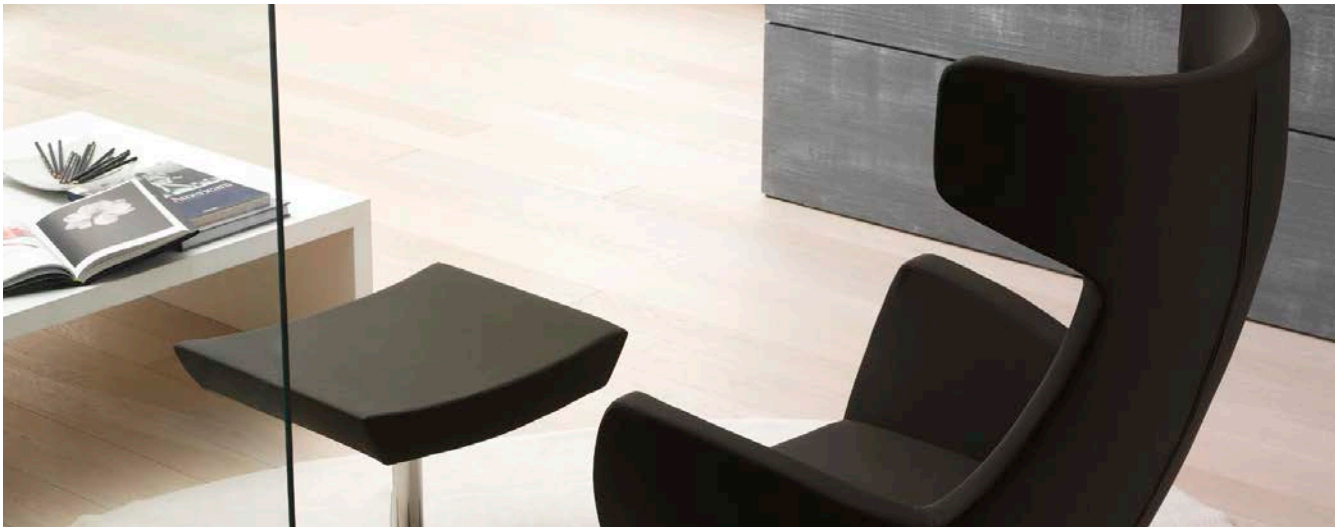

Paris

Overall Size (mm)	770W x 740D x 910H
Seat Height (mm)	430
Arm Height (mm)	670



L10 natural timber leg.



D7 steel swivelling base



R13 Chrome swivelling base

Prestige

Overall Size (mm)	770W x 740D x 1150H
Seat Height (mm)	410
Arm Height (mm)	650



L21 Stained or raw ash wood



D7 steel swivelling base



R13 chrome swivelling base

Sixty & Queen

Generous and comfortable, the Sixty and Queen are versatile Italian made and designed by Rossetto. Available in a range of different base options and upholstered in the fabric of your choice.

POPULAR OPTIONS

BASES	GL - timber (Sixty) R13 - chrome swivelling L21 - ash wood base (Queen) L14 - ash wood base (Queen) D9 - steel swivelling (Queen)
FINISHES	Dark or Natural stained timber Polished chrome
FABRIC	Your choice of any fabric .



ROSSETTO

Sixty

Overall Size (mm)	810W x 760D x 940H
Seat Height (mm)	420
Arm Height (mm)	600



GL stained or raw timber legs.



R13 polished chrome metal swivelling base.



Queen

Overall Size (mm)	780W x 760D x 1170H
Seat Height (mm)	420
Arm Height (mm)	650



L21 stained or raw ash wood



D9 steel swivelling base



R13 Chrome swivelling base



L14 stained or raw ash wood

Zelig by Rossetto

New modular seating system designed by Rossetto, consists of three base sizes, each configured with your choice of foams and/or tops. To be creatively arranged and connected to suit your office, reception, waiting-area, or foyers space requirements. Top it off with your fabric choice.

In-stock and ready to upholster now. Bases and table top in raw or painted beech wood. Option to fix and unfix bases together using a bracket.

To assist you and your customers ChairSolutions offers visualisations of your unique configuration. Contact us for assistance.

2D and 3D CAD files available at <http://chair.solutions/zelig>



Zelig Tops

Corner Overall (mm)	650W x 650D x 450H
Straight Overall (mm)	600W x 650D x 450H
Backless Overall (mm)	600W x 600D
Table Top Overall	600W x 600D



Straight foam.



Corner foam.



Backless foam.



Wooden table top.

Zelig Bases

Single Seater (mm)	600W x 600D x 420H
Two Seater (mm)	1200W x 600D x 420H
Three Seater (mm)	1800W x 600D x 420H



Single seater base.



Two seater base.



Three seater base.

Popular Modules



1x three seater base + 2x corner foams + 1x straight foam.



1x two seater base + 1x corner foam + 1x straight foam.



Zelig ottoman.



1x three seater base + 1x backless foam
+ 2x straight foams.



1x three seater base + 2x backless foams
+ 1x table top.



Zelig table.

Zorb Acoustics

As we plan for new workplaces and for modifications to existing workplaces, there are a few simple acoustical concepts that can help ensure a better outcome for the employee's satisfaction and the success of the enterprise. Zorb creates a quiet environment and fills the need for more productive work.

In stock and ready to upholster now

COLOUR OPTIONS

Black, grey, white, beige, yellow, orange, red, purple, green, blue

Contact your rep for colour samples

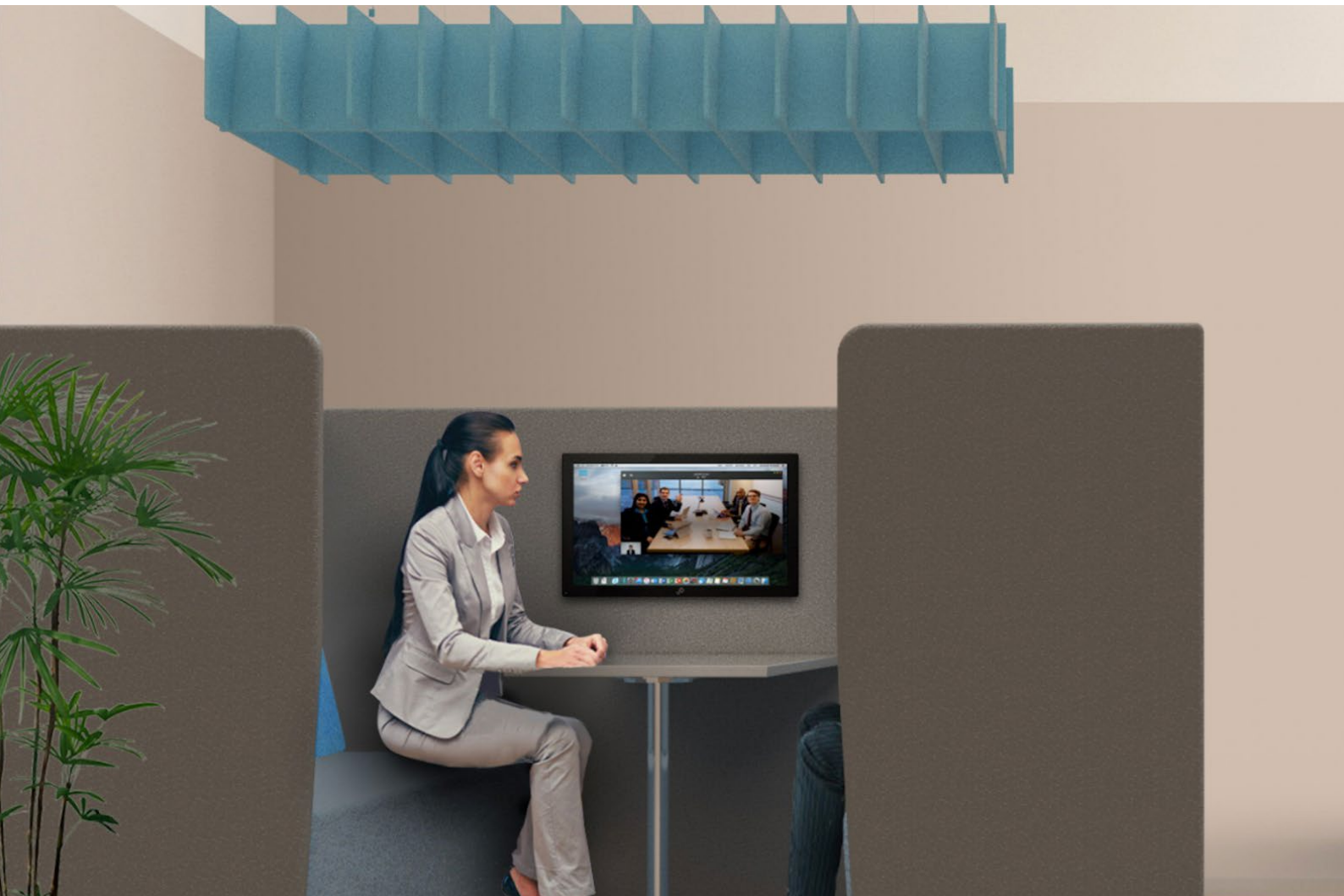

Zorb Lounge

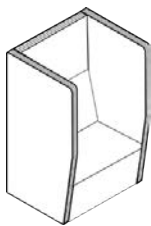

QUIET LOUNGE
1, 2 or 3 seater

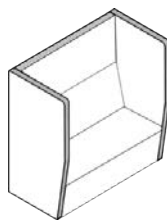

QUIET LOUNGE
1, 2 or 3 seater

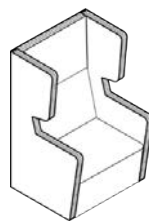

WING LOUNGE
1, 2 or 3 seater

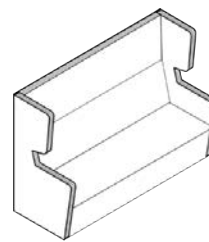

WING LOUNGE
1, 2 or 3 seater

Zorb Booths & Pods

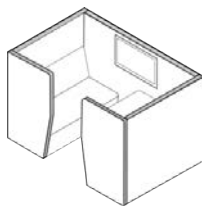

QUIET POD

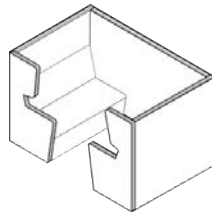

QUIET WING POD

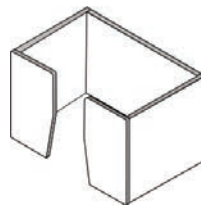

POD SURROUND

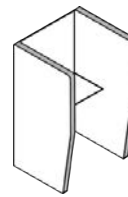

PHONE BOOTH
Wall mounted or free standing

Zorb Work

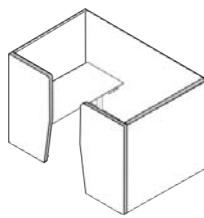

WORK POD
Ascend system

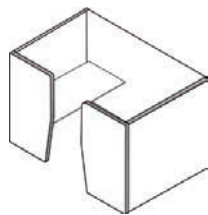

WORK POD
Fixed desk



WORK SOLO
900 or 1800W



DIVVY
Single, triple or custom

Zorb Pinboard & Screens

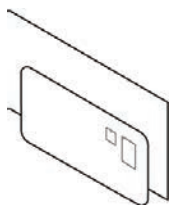

PINBOARD
Various sizes

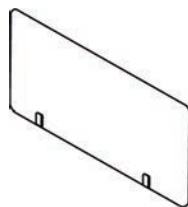

BRACKET SCREEN
Various sizes



MOUNTED SCREEN
Various sizes

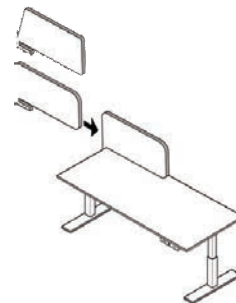

SLIP ON SCREEN
Lozenge or Arrow,
various sizes

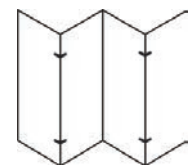

PARTITION
Various sizes

Zorb Wall & Ceiling

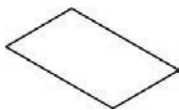

CEILING TILE
Various sizes



WALL TILE
Peel and stick,
Various sizes



WALL ART/ HANGERS
Various designs available

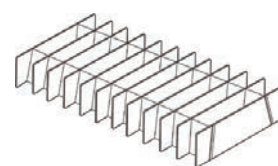

CEILING BAFFLE

Flite Beam Seating

Flite is a beam-type seating system designed for public areas such as airports, stations, malls and museums. Design details are carefully thought out such as hidden screws from view. Flite is available in two, three, four or more seats according to requirement.



ACCESSORIES

SIDE TABLE LINKING Optional steel side table. Seat rows can be linked back to back.

COLOUR OPTIONS



Flite

- Optionally with or without arms.
- Multiple configurations available.
- Diecast aluminium frame adds a premium appearance while providing robust strength for heavy public use.
- Seats resist spills and wipes dry instantly.
- Levelling adjustable feet.
- Frame components are 100% recyclable
- 5 year Aus. manufacturer warranty.

Seat Size (mm)	495W x 690D
Overall Height (mm)	805
Seat Height (mm)	425
Arm Height (mm)	575

Seats

Available in 2, 3, 4 and 6 seaters. Seats are moulded in integral PU foam, over a steel frame in a standard grey colour.

Seat Supporter

Diecast aluminium in a polished finish (100% recyclable).



Beam Structure

Rectangular section made of steel in a silver epoxy powder coat.

Side Table

Laser cut mild steel plate in a textured silver epoxy powder coat.

Armrests, legs and frame components

Diecast aluminium in a polished finish (100% recyclable).

Levelling feet

Adjustable black polypropylene feet for levelling on uneven floors.

Configurations

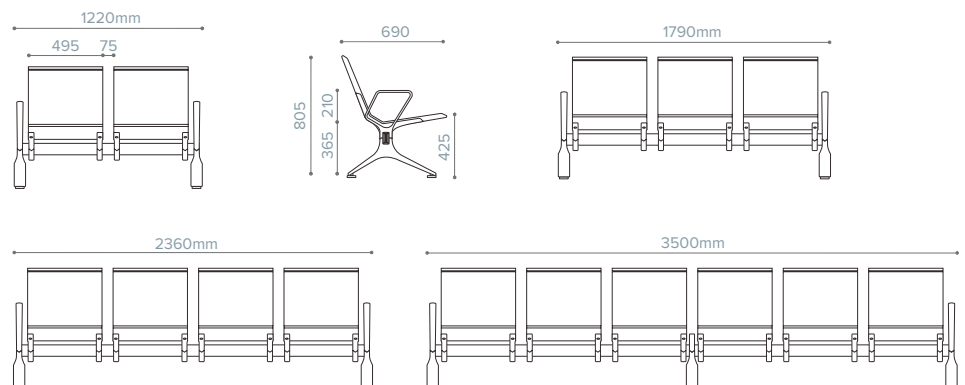



ADDRESS

12 / 324 Settlement Road
Thomastown VIC 3074
Australia

PHONE

03 9348 2000

FAX

03 8677 2899

EMAIL

sales@nexusinteriors.com.au

nexus
interiors
— australia

nexusinteriors.com.au

