



nexus
interiors
— australia

Seating for Activity-Based Working: *For the 21st century workspace.*



Custom colours. Quick delivery. Exceptional value. Australian made quality.

The changing way of work

The way we work in Australia is changing, which is why many offices are complementing their traditional cubicle or hot-desk set-ups with activity-based working (ABW).

We offer a range of ABW Seating to meet the needs of the modern Australian organisation - from communal breakout lounges to semi-private pods for focused work.

Stylish, flexible and incredibly cost effective, ABW Seating is the smart choice for the 21st-century business.





PROUDLY
AUSTRALIAN
MADE



The new kind of workplace seating

Our selection of ABW Seating is built for flexibility, efficiency and style.

Featuring a range of booths, lounges, ottomans, focus pods and visitor chairs, our activity-based modules can be combined and customised to meet the diverse needs of any modern-day enterprise.

The seats are soft, supportive and available in a variety of colours, from classic blacks and greys to vibrant reds, greens and blues. Businesses can even supply their own fabric for the ultimate in custom seating.

Cost-effective, functional, and with a healthy dose of originality, ABW Seating helps 21st-century businesses create a 21st-century workspace.

- ✓ Contemporary styles to suit the modern office fit-out
- ✓ Covered in soft-yet-sturdy fabric with a subtle linen weave
- ✓ Mix and match from 16 striking colours, or BYO fabric to match your existing decor
- ✓ Customised configurations to meet the needs of any business
- ✓ Manufactured in Australia, with a six week lead time



Amee Page 6



Khloe Page 8



Yara Standard Page 10



Yara Tall Page 12



Zara Page 14



Pebble Page 16



Otto Page 18



Park Standard Page 20
Park Tall Page 22



Flix Standard Page 24
Flix Tall Page 26



Flo Standard Page 28
Flo Tall Page 30

Valuable & Flexible Fit-outs

ABW Seating adds value to a space. It is easy to move, can be combined with traditional workstations and gives you the flexibility to alter your office space as your project or workforce changes.

Collaboration

Improves collaboration and knowledge sharing – teams can have a catch-up in a pod or breakout area, in addition to formal meeting rooms.

Concentration

Enhances concentration for focused tasks. Open-plan offices are great, but some people find background noise distracting. Providing 'focus rooms' lets staff have a quiet space for tasks that require serious concentration.

Benefits of an activity-based workplace

Valuable & Flexible Fitouts

Collaboration

Concentration

Active Employees

Empowers Staff

Attract & Retain Staff



Attract and Retain Staff

Activity-based working is fast becoming a major selling point for recruitment. Increased choice, better interactions with colleagues and a more appealing office environment improves employee satisfaction and helps businesses attract and retain staff.



Empowers Staff

We all have different needs and preferences around our working habits. Activity-based working recognises this and lets staff decide how and where they work best for each task.



More Active Employees

Moving between areas depending on their current task means staff are less sedentary during the day. That encourages better health and can reduce sick days.

Amee

Amee is a comfortable, flexible and versatile soft seating solution where employees can escape workplace distractions. Boasting a creative form, Amee is characterised by unique wings that function as a quiet space for thoughtful deliberation and focused discussion. Stylish 120mm chrome feet further enhance its appeal.

Feature Highlights

- Available in any fabric to suit your colour scheme
- Popular range of booth seating
- Modern 120mm chrome feet



1 Seater Booth

Amee

| Code | Description | External (mm) | | | Seat (mm) | | Meterage |
|----------|-----------------------|---------------|-------|-------|-----------|-------|----------|
| | | Height | Width | Depth | Height | Depth | |
| AMEET1 | Amee 1 Seater Booth | 1170 | 740 | 770 | 450 | 500 | 7 |
| AMEET2 | Amee 2 Seater Booth | 1170 | 1340 | 770 | 450 | 500 | 8 |
| AMEET2.5 | Amee 2.5 Seater Booth | 1170 | 1640 | 770 | 450 | 500 | 9 |
| AMEET3 | Amee 3 Seater Booth | 1170 | 1940 | 770 | 450 | 500 | 10 |



PROUDLY AUSTRALIAN MADE



2 Seater Booth

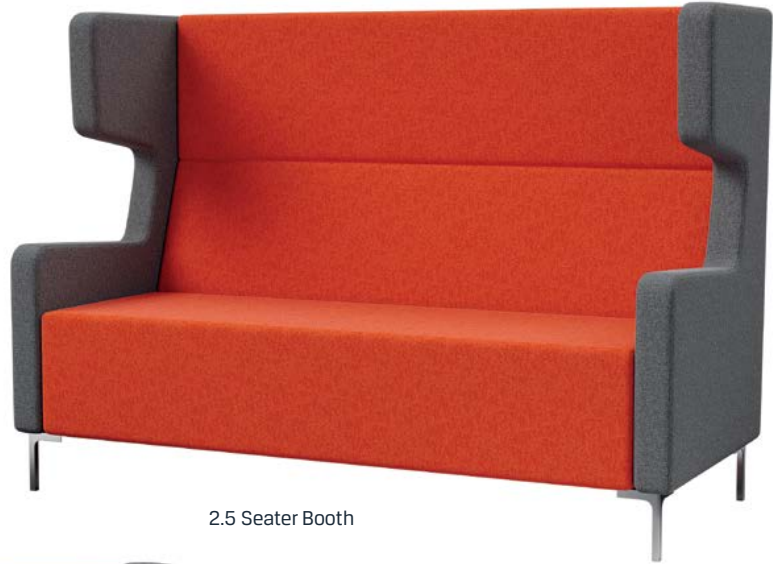

2.5 Seater Booth



3 Seater Booth

Amee Range

Fabric A Fabric B

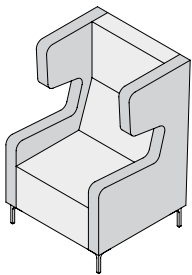

1 Seater
AMEET1

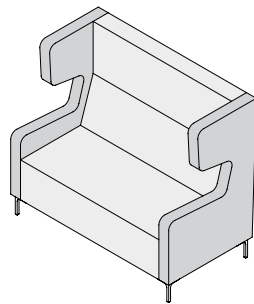

2 Seater
AMEET2

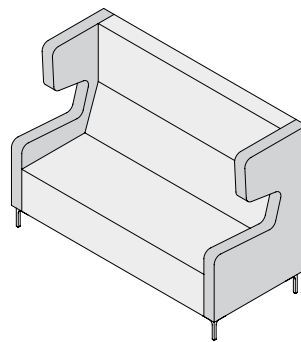

2.5 Seater
AMEET2.5

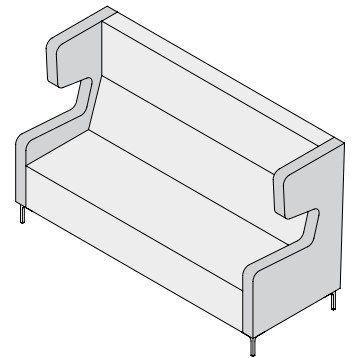

3 Seater
AMEET3

Khloe

The acoustically designed Khloe features wings on either side and overhead. This innovative design is teamed with 120mm high chrome feet and ensures Khloe is visually striking and equally serviceable as a private setting to place an important call or hold an uninterrupted discussion.

Feature Highlights

- Available in any fabric to suit your colour scheme
- Booth seating
- Acoustic wings offer a private setting



1 Seater Booth

Khloe

| Code | Description | External (mm) | | | Seat (mm) | | Meterage |
|-------------|------------------------|---------------|-------|-------|-----------|-------|----------|
| | | Height | Width | Depth | Height | Depth | |
| KHLOE1SLW | Khloe 1 Seater Booth | 1570 | 700 | 710 | 450 | 520 | 9.1 |
| KHLOE2SLW | Khloe 2 Seater Booth | 1570 | 1350 | 710 | 450 | 520 | 11.1 |
| KHLOE2.5SLW | Khloe 2.5 Seater Booth | 1570 | 1550 | 710 | 450 | 520 | 13.5 |



PROUDLY
AUSTRALIAN
MADE



2 Seater Booth



2.5 Seater Booth

Khloe Range

■ Fabric A ■ Fabric B

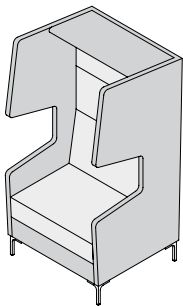

1 Seater
KHLOE1SLW

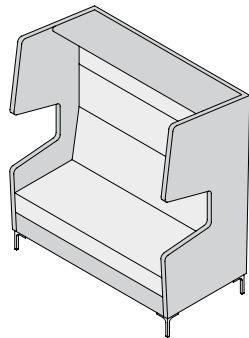

2 Seater
KHLOE2SLW

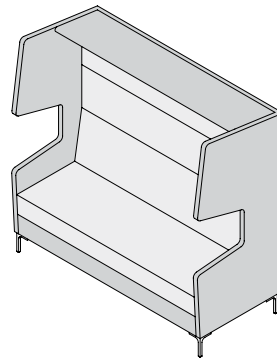

2.5 Seater
KHLOE2.5SLW

Yara Standard

The cleverly designed Yara offers the mobility demanded of activity-based work whilst allowing for privacy. The Yara sits proudly on 120mm high chrome feet and is offered in two back heights for added flexibility. The standard back defines a place to work or relax, whilst the tall back provides added privacy for an important conversation or solitary concentration.

Feature Highlights

- Available in 2 tone fabric scheme
- Acoustic properties of design
- Optional power & usb port available

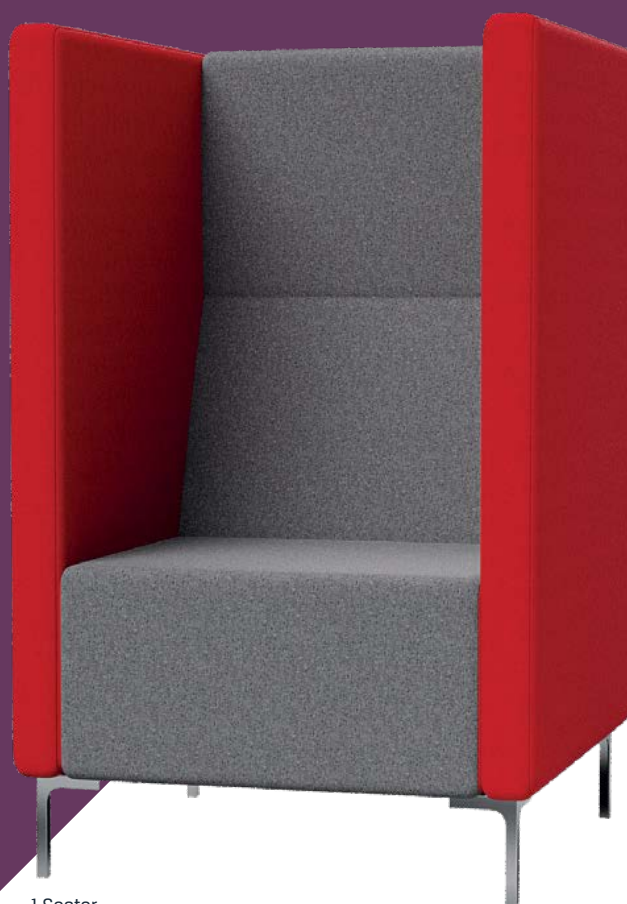

Yara Standard

| Code | Description | External (mm) | | | Seat (mm) | | Meterage |
|-----------|-------------------------------|---------------|-------|-------|-----------|-------|----------|
| | | Height | Width | Depth | Height | Depth | |
| YARASB1 | Yara Standard Back 1 Seater | 1200 | 750 | 760 | 450 | 520 | 6.3 |
| YARASB2 | Yara Standard Back 2 Seater | 1200 | 1350 | 760 | 450 | 520 | 7.7 |
| YARASB2.5 | Yara Standard Back 2.5 Seater | 1200 | 1650 | 760 | 450 | 520 | 8.6 |
| YARASB3 | Yara Standard Back 3 Seater | 1200 | 1950 | 760 | 450 | 520 | 10.2 |



PROUDLY
AUSTRALIAN
MADE



2 Seater



2.5 Seater



3 Seater

Yara Standard Range

Fabric A Fabric B

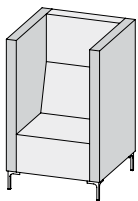

1 Seater
YARASB1

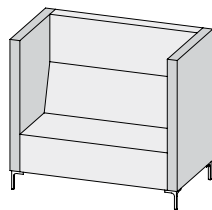

2 Seater
YARASB2

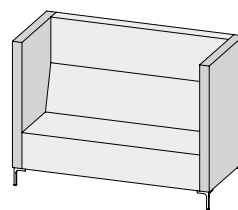

2.5 Seater
YARASB2.5

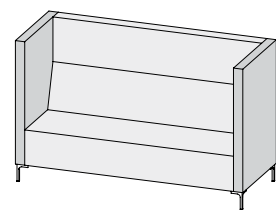

3 Seater
YARASB3

Yara Tall

The cleverly designed Yara offers the mobility demanded of activity-based work whilst allowing for privacy. The Yara sits proudly on 120mm high chrome feet and is offered in two back heights for added flexibility. The standard back defines a place to work or relax, whilst the tall back provides added privacy for an important conversation or solitary concentration.

Feature Highlights

- Available in 2 tone fabric scheme
- Acoustic properties of design
- Optional power & usb port available

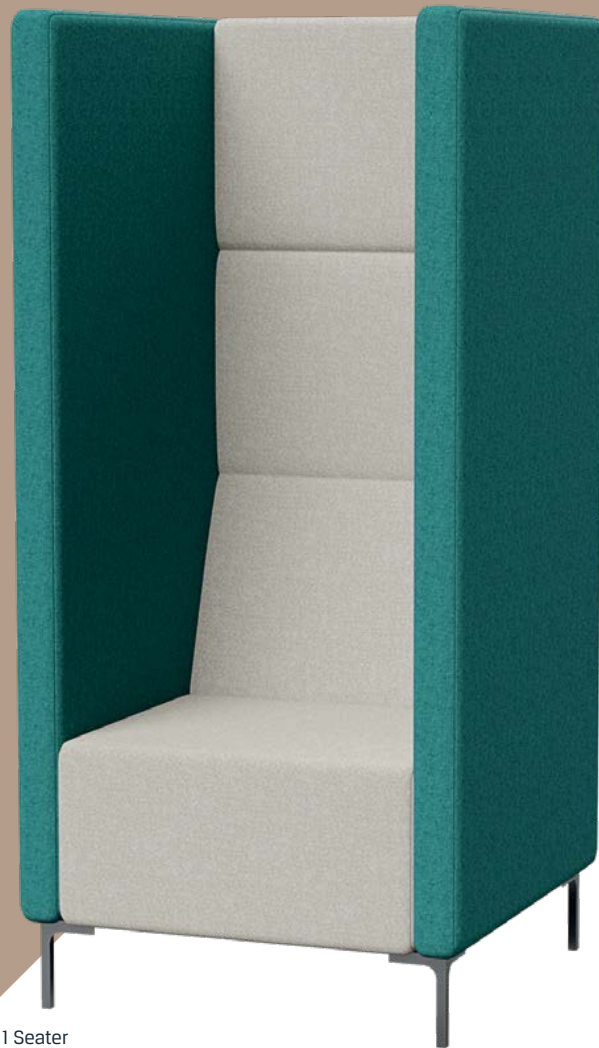

1 Seater

Yara Tall

| Code | Description | External (mm) | | | Seat (mm) | | Meterage |
|-----------|---------------------------|---------------|-------|-------|-----------|-------|----------|
| | | Height | Width | Depth | Height | Depth | |
| YARATB1 | Yara Tall Back 1 Seater | 1600 | 750 | 760 | 450 | 520 | 8.5 |
| YARATB2 | Yara Tall Back 2 Seater | 1600 | 1350 | 760 | 450 | 520 | 10.0 |
| YARATB2.5 | Yara Tall Back 2.5 Seater | 1600 | 1650 | 760 | 450 | 520 | 12.0 |
| YARATB3 | Yara Tall Back 3 Seater | 1600 | 1950 | 760 | 450 | 520 | 12.7 |



PROUDLY AUSTRALIAN MADE



2 Seater



2.5 Seater



3 Seater

Yara Tall Range

Fabric A Fabric B

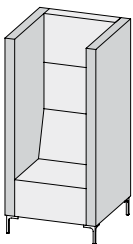

1 Seater
YARATB1

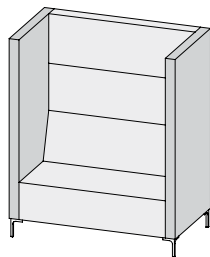

2 Seater
YARATB2

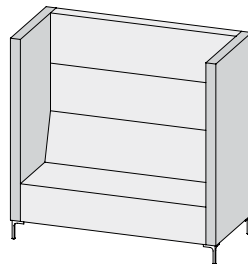

2.5 Seater
YARATB2.5

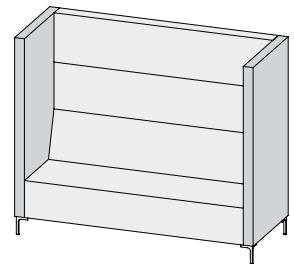

3 Seater
YARATB3

Zara

The contemporary design of Zara is paired with sturdy wooden feet to create a homely comfort factor that will extend a warm welcome in a reception or executive offices. Stand Zara alone as a cosy place to pass time, or pair to create a relaxed atmosphere for one-to-one conversation.

Feature Highlights

- Available in any fabric to suit your colour scheme
- Versatile standalone office chair
- Unique wooden feet



1 Seater Booth

Zara

| Code | Description | External (mm) | | | Seat (mm) | | Meterage |
|--------|---------------------|---------------|-------|-------|-----------|-------|----------|
| | | Height | Width | Depth | Height | Depth | |
| ZARA1S | Zara 1 Seater Booth | 1100 | 850 | 750 | 450 | 520 | 6 |
| ZARA2S | Zara 2 Seater Booth | 1100 | 1500 | 750 | 450 | 520 | 8 |



PROUDLY
AUSTRALIAN
MADE



2 Seater Booth

Zara Range

Fabric A Fabric B

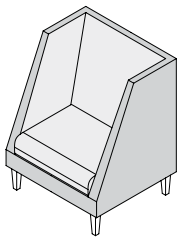

1 Seater
ZARA1S

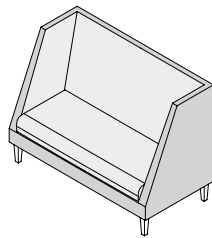

2 Seater
ZARA2S

Pebble

Pebble is a functional ottoman in an inspired form, that is ideal for workplaces aspiring to a creative vibe. Designed for comfort, the Pebble uses little floor space and is easily moved to quickly adapt to Australians ever-changing work days.

Feature Highlights

- Select a fabric colour to match existing furniture
- Superior quality, top stitched
- Create quick seating options



Ottoman
1200mm wide

Pebble

| Code | Description | External (mm) | | | Seat (mm) | | Meterage |
|-------------|---------------------------------|---------------|-------|-------|-----------|-------|----------|
| | | Height | Width | Depth | Height | Depth | |
| PEBBLESEAT | Pebble Highrise Seat 450mm wide | 650 | 450 | 450 | 650 | 450 | 1.3 |
| PEBBLE450W | Pebble Ottoman 450mm wide | 450 | 450 | 450 | 450 | 450 | 0.8 |
| PEBBLE600W | Pebble Ottoman 600mm wide | 450 | 600 | 600 | 450 | 600 | 1.3 |
| PEBBLE900W | Pebble Ottoman 900mm wide | 450 | 900 | 900 | 450 | 900 | 1.9 |
| PEBBLE1200W | Pebble Ottoman 1200mm wide | 450 | 1200 | 1200 | 450 | 1200 | 3.2 |
| PEBBLE1500W | Pebble Ottoman 1500mm wide | 450 | 1500 | 1500 | 450 | 1500 | 4.6 |

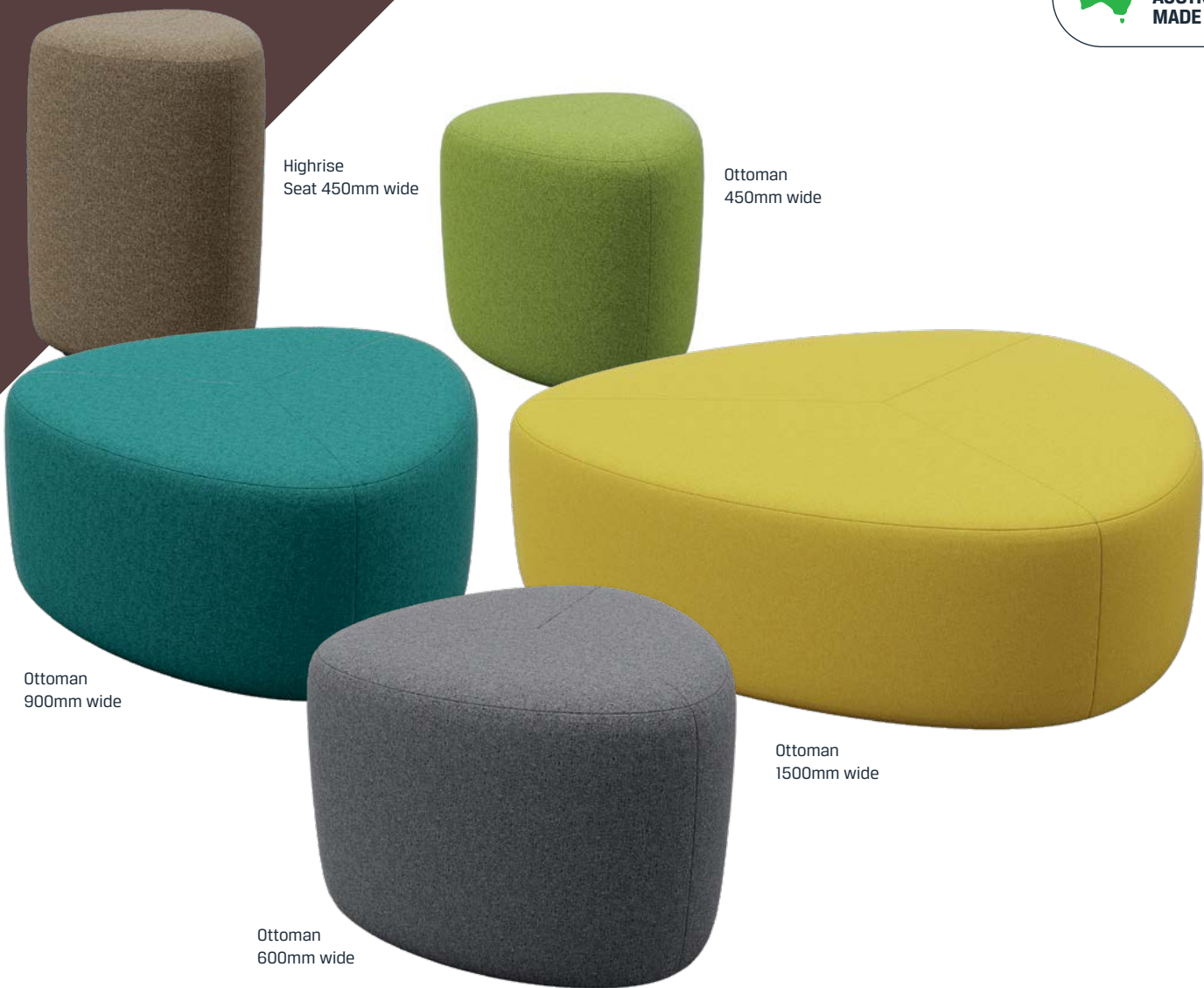

Highrise Seat 450mm wide

Ottoman 450mm wide

Ottoman 900mm wide

Ottoman 1500mm wide

Ottoman 600mm wide

Pebble Range

Fabric A

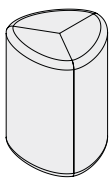

Highrise Seat
PEBBLESEAT

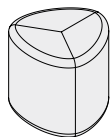

Ottoman 450mm
PEBBLE450W

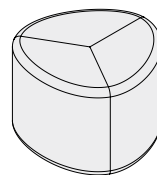

Ottoman 600mm
PEBBLE600W

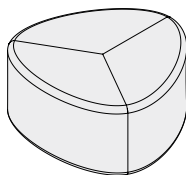

Ottoman 900mm
PEBBLE900W

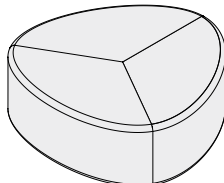

Ottoman 1200mm
PEBBLE1200W

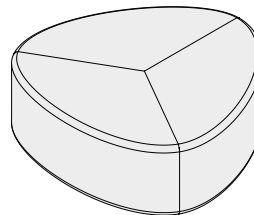

Ottoman 1500mm
PEBBLE1500W

Otto

Otto is a simple and versatile solution to supplement workspaces. The round single seats are easily portable, whilst larger options make a striking centre piece and casual meeting place for work teams. Alternatively, add a back for comfortable breakout seating around workstations.

Feature Highlights

- Round or curved shape
- Option to add a back
- Available in any fabric to suit your colour scheme

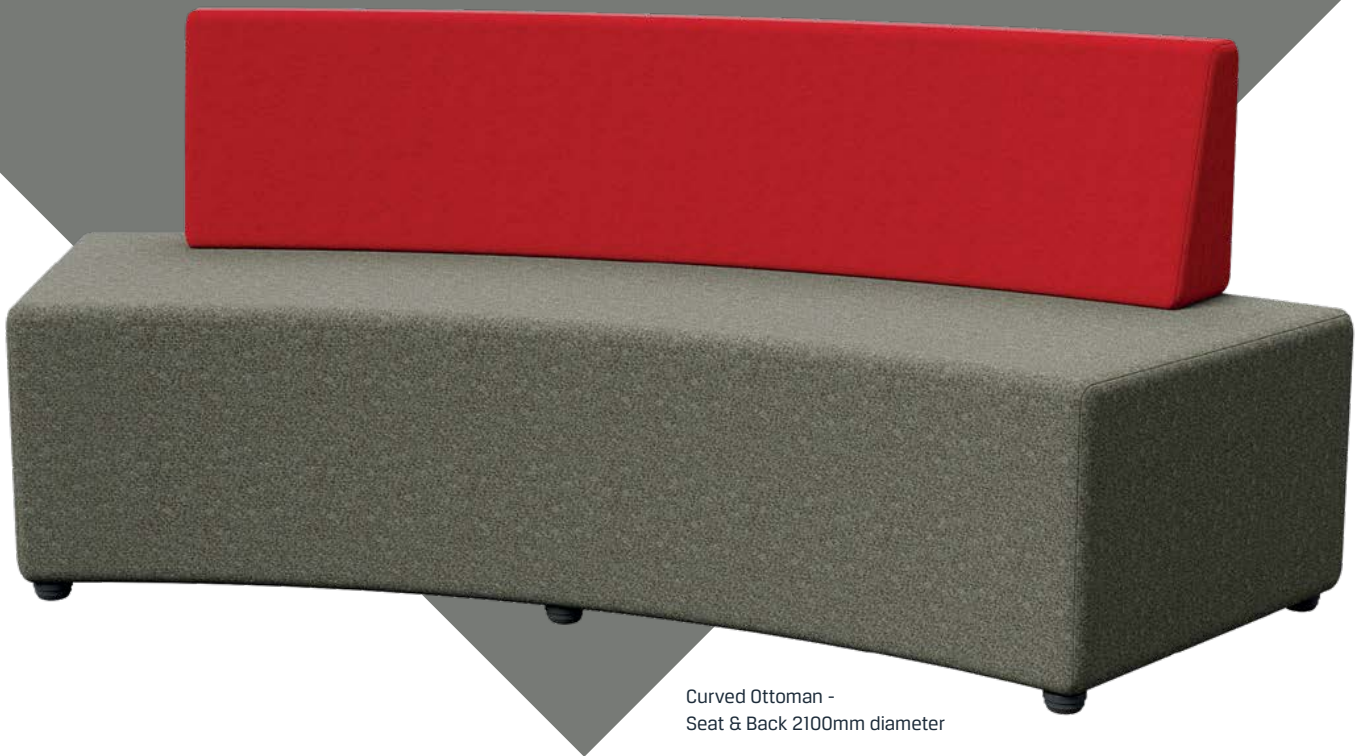

Otto – Mix Round

| Code | Description | External (mm) | | | Seat (mm) | | Meterage |
|-----------------------|--|---------------|-------|-------|-----------|-------|----------|
| | | Height | Width | Depth | Height | Depth | |
| OTTOMIXROUND450DIA | Otto Mix Round Ottoman 450mm diameter | 450 | 450 | 450 | 450 | 450 | 1.5 |
| OTTOMIXROUND500DIA | Otto Mix Round Ottoman 500mm diameter | 450 | 500 | 500 | 450 | 500 | 1.5 |
| OTTOMIXROUND600DIA | Otto Mix Round Ottoman 600mm diameter | 450 | 600 | 600 | 450 | 600 | 1.7 |
| OTTOMIXROUND600DIA-BT | Otto Mix Round Ottoman 600mm diameter - Bite | 450 | 600 | 600 | 450 | 600 | 1.7 |
| OTTOMIXROUND900DIA | Otto Mix Round Ottoman 900mm diameter | 450 | 900 | 900 | 450 | 900 | 3.0 |
| OTTOMIXROUND1200DIA | Otto Mix Round Ottoman 1200mm diameter | 450 | 1200 | 1200 | 450 | 1200 | 3.7 |
| OTTOMIXROUND1500DIA | Otto Mix Round Ottoman 1500mm diameter | 450 | 1500 | 1500 | 450 | 1500 | 5.0 |



Curved Ottoman -
Seat Only 1200mm diameter



Round Ottoman -
1200mm diameter



Curved Ottoman -
Seat & Back 1500mm diameter

Otto Range

Fabric A Fabric B

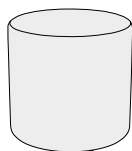

Round Ottoman
OTTOMIXROUND450DIA

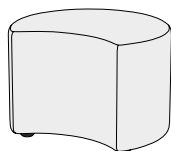

Round Ottoman Bite
OTTOMIXROUND600DIA-BT

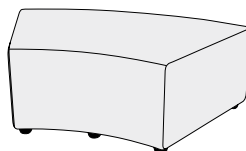

Curved Ottoman
OTTOMIXCURVE1200S

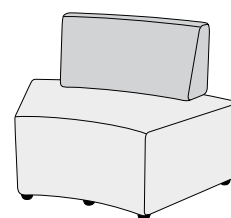

Curved Ottoman Seat & Back
OTTOMIXCURVE1200SB

Otto – Mix Curved

| Code | Description | External (mm) | | | Seat (mm) | | Meterage |
|--------------------|---|---------------|-------|---------|-----------|-------|----------|
| | | Height | Width | Depth | Height | Depth | |
| OTTOMIXCURVE1200S | Otto Mix Curved Ottoman - Seat Only 1200mm diameter | 450 | 1200 | 770/700 | 450 | 700 | 2.6 |
| OTTOMIXCURVE1500S | Otto Mix Curved Ottoman - Seat Only 1500mm diameter | 450 | 1500 | 800/700 | 450 | 700 | 3.2 |
| OTTOMIXCURVE1800S | Otto Mix Curved Ottoman - Seat Only 1800mm diameter | 450 | 1800 | 830/700 | 450 | 700 | 4 |
| OTTOMIXCURVE2100S | Otto Mix Curved Ottoman - Seat Only 2100mm diameter | 450 | 2100 | 860/700 | 450 | 700 | 4.6 |
| OTTOMIXCURVE2400S | Otto Mix Curved Ottoman - Seat Only 2400mm diameter | 450 | 2400 | 890/700 | 450 | 700 | 5.3 |
| OTTOMIXCURVE2700S | Otto Mix Curved Ottoman - Seat Only 2700mm diameter | 450 | 2700 | 920/700 | 450 | 700 | 5.8 |
| OTTOMIXCURVE1200SB | Otto Mix Curved Ottoman - Seat & Back 1200mm diameter | 820 | 1200 | 770/700 | 450 | 500 | 3.9 |
| OTTOMIXCURVE1500SB | Otto Mix Curved Ottoman - Seat & Back 1500mm diameter | 820 | 1500 | 800/700 | 450 | 500 | 4.8 |
| OTTOMIXCURVE1800SB | Otto Mix Curved Ottoman - Seat & Back 1800mm diameter | 820 | 1800 | 830/700 | 450 | 500 | 5.9 |
| OTTOMIXCURVE2100SB | Otto Mix Curved Ottoman - Seat & Back 2100mm diameter | 820 | 2100 | 860/700 | 450 | 500 | 6.8 |
| OTTOMIXCURVE2400SB | Otto Mix Curved Ottoman - Seat & Back 2400mm diameter | 820 | 2400 | 890/700 | 450 | 500 | 7.8 |
| OTTOMIXCURVE2700SB | Otto Mix Curved Ottoman - Seat & Back 2700mm diameter | 820 | 2700 | 920/700 | 450 | 500 | 8.6 |

Park Standard

The versatility of Park make it the perfect seating option for breakout spaces and ad-hoc meeting areas. Featuring a smooth aesthetic design and clever modular construction, Park offers multiple configurations to inspire imaginative workplaces. Position Park in a circle to define a team meeting area, or use independently by adding arms, a laptop table and a matching ottoman.

Feature Highlights

- Versatile & modular layout
- Smooth aesthetic design
- Option to add arms & matching ottoman



1.5 Seater Inner-Curve Standard Back (45 degree)

Park Standard

| Code | Description | External (mm) | | | Seat (mm) | | Meterage |
|------------------|---|---------------|----------|-------|-----------|-------|----------|
| | | Height | Width | Depth | Height | Depth | |
| PARK1S30DEGCO | Park 1 Seater Outer-Curve Ottoman (30 degree) | 450 | 900/500 | 740 | 450 | 740 | 2.4 |
| PARK1.5S45DEGCO | Park 1.5 Seater Outer-Curve Ottoman (45 degree) | 450 | 1300/750 | 740 | 450 | 740 | 3.1 |
| PARK1SSB | Park 1 Seater Standard Back | 770 | 650 | 740 | 450 | 555 | 2.5 |
| PARK2SSB | Park 2 Seater Standard Back | 770 | 1300 | 740 | 450 | 555 | 3.8 |
| PARK1S30DEGCIB | Park 1 Seater Inner-Curve Standard Back (30 degree) | 770 | 900/500 | 740 | 450 | 555 | 2.6 |
| PARK1S30DEGCOB | Park 1 Seater Outer-Curve Standard Back (30 degree) | 770 | 900/500 | 740 | 450 | 555 | 3.2 |
| PARK1.5S45DEGCIB | Park 1.5 Seater Inner-Curve Standard Back (45 degree) | 770 | 1300/750 | 740 | 450 | 555 | 3.4 |
| PARK1.5S45DEGCOB | Park 1.5 Seater Outer-Curve Standard Back (45 degree) | 770 | 1300/750 | 740 | 450 | 555 | 4.6 |
| PARK1SCNRRH | Park Corner Seater Standard Back - Right Hand | 770 | 770 | 740 | 450 | 555 | 3.6 |
| PARK1SCNRLH | Park Corner Seater Standard Back - Left Hand | 770 | 770 | 740 | 450 | 555 | 3.6 |
| PARK1SSO | Park Ottoman 650mm | 450 | 650 | 740 | 450 | 740 | 2.2 |
| PARK2SSO | Park Ottoman 1300mm | 450 | 1300 | 740 | 450 | 740 | 3.3 |

Park Standard Range

Fabric A Fabric B

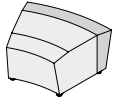

1 Seater Outer-Curve Ottoman
(30 degree)
PARK1S30DEGCO

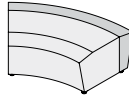

1.5 Seater Outer-Curve Ottoman
(45 degree)
PARK1.5S45DEGCO

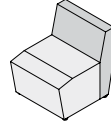

1 Seater Standard Back
PARK1SSB

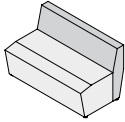

2 Seater Standard Back
PARK2SSB

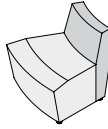

1 Seater Inner-Curve Standard Back
(30 degree)
PARK1S30DEGCIB

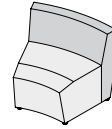

1 Seater Outer-Curve Standard Back
(30 degree)
PARK1S30DEGCOB

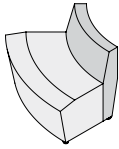

1.5 Seater Inner-Curve Standard Back
(45 degree)
PARK1.5S45DEGCIB

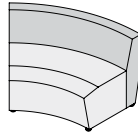

1.5 Seater Outer-Curve Standard Back
(45 degree)
PARK1.5S45DEGCOB

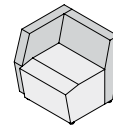

Corner Seater Standard Back - Right Hand
PARK1SCNRRH

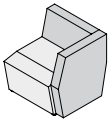

Corner Seater Standard Back - Left Hand
PARK1SCNRLH

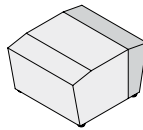

Ottoman 650mm
PARK1SSO

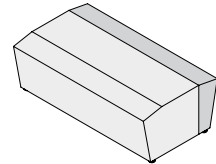

Ottoman 1300mm
PARK2SSO

Configuration Options

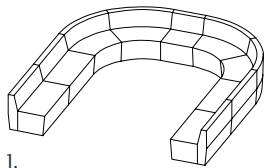

1.

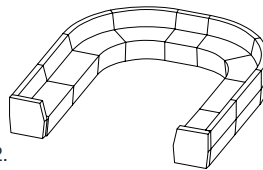

2.

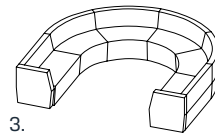

3.

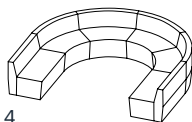

4.

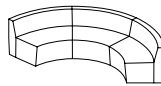

5.

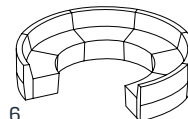

6.

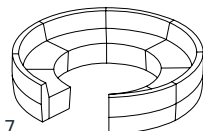

7.

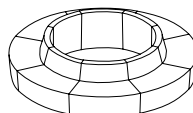

8.

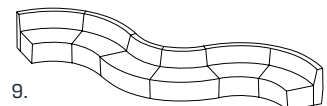

9.

Park Tall

For added privacy, extra back and neck support, and comfort, the Park is also available in a tall version. The height of the back provides a semi-enclosed, cocoon type working environment enabling persons to have 'their own space' amongst a busy workplace. The taller version is ideal for activities requiring heightened focus and concentration, or even phone discussions.

Feature Highlights

- Versatile & modular layout
- Smooth aesthetic design
- Option to add arms & matching ottoman



1.5 Seater Inner-Curve Tall Back (45 degree)

Park Tall

| Code | Description | External (mm) | | | Seat (mm) | | | Meterage |
|-------------------|---|---------------|----------|-------|-----------|-------|-----|----------|
| | | Height | Width | Depth | Height | Depth | | |
| PARK1SSTB | Park 1 Seater Tall Back | 1110 | 650 | 740 | 450 | 555 | 3.5 | |
| PARK2SSTB | Park 2 Seater Tall Back | 1110 | 1300 | 740 | 450 | 555 | 5.3 | |
| PARK1S30DEGCITB | Park 1 Seater Inner-Curve Tall Back (30 degree) | 1110 | 900/500 | 740 | 450 | 555 | 3.6 | |
| PARK1S30DEGCOTB | Park 1 Seater Outer-Curve Tall Back (30 degree) | 1110 | 900/500 | 740 | 450 | 555 | 4.2 | |
| PARK1.5S45DEGCITB | Park 1.5 Seater Inner-Curve Tall Back (45 degree) | 1110 | 1320/750 | 740 | 450 | 555 | 4.4 | |
| PARK1.5S45DEGCOTB | Park 1.5 Seater Outer-Curve Tall Back (45 degree) | 1110 | 1320/750 | 740 | 450 | 555 | 6 | |
| PARK1SCNRRHTB | Park Corner Seater Tall-Back - Right Hand | 1110 | 760 | 740 | 450 | 555 | 5.6 | |
| PARK1SCNRLHTB | Park Corner Seater Tall-Back - Left Hand | 1110 | 760 | 740 | 450 | 555 | 5.6 | |
| PARK1SSO | Park Ottoman 650mm | 450 | 650 | 740 | 450 | 740 | 2.2 | |
| PARK2SSO | Park Ottoman 1300mm | 450 | 1300 | 740 | 450 | 740 | 3.3 | |

Park Tall Range

Fabric A Fabric B Fabric C

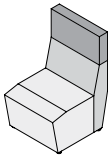

1 Seater Tall Back
PARK1SSTB

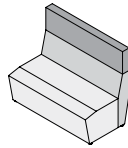

2 Seater Tall Back
PARK2SSTB

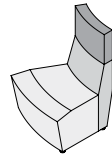

1 Seater Inner-Curve Tall Back
(30 degree)
PARK1S30DEGCITB

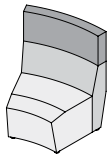

1 Seater Outer-Curve Tall Back
(30 degree)
PARK1S30DEGCOTB

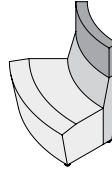

1.5 Seater Inner-Curve Tall Back
(45 degree)
PARK1.5S45DEGCITB

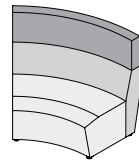

1.5 Seater Outer-Curve Tall Back
(45 degree)
PARK1.5S45DEGCOTB

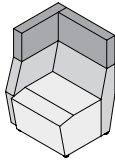

Corner Seater Tall-Back - Right Hand
PARK1SCNRRHTB

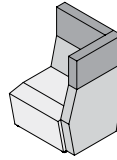

Corner Seater Tall-Back - Left Hand
PARK1SCNRLHTB

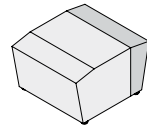

Ottoman 650mm
PARK1SSO

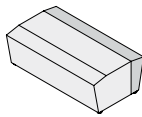

Ottoman 1300mm
PARK2SSO

Configuration Options

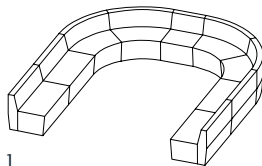

1.

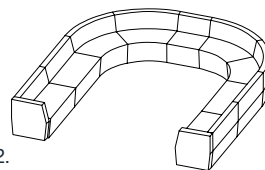

2.

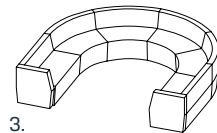

3.

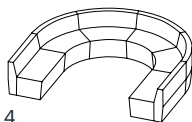

4.

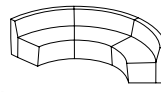

5.

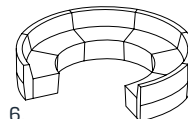

6.

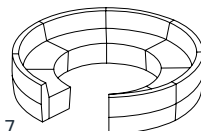

7.

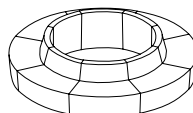

8.

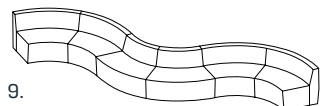

9.

Flix Standard

Flix comprises modular seating in straight, curved and round shapes to inspire creativity, conversation and collaboration. Choose to add rectangular shaped arms and tall backs to enclose spaces where teams can huddle. Alternatively, combine curved modules into an endless wave for a fun, imaginative and social setting. The addition of optional matching ottomans completes the space.

Feature Highlights

- Large range of modular configuration options for; Booth Seating, Banquet Seating, Arena Seating & Huddle spaces
- Option to add rectangular shaped arms and matching ottoman



1 Seater Curved INNER Standard Back

Flix Standard

| Code | Description | External (mm) | | | Seat (mm) | | Meterage |
|----------------|--|---------------|-----------|-------|-----------|-------|----------|
| | | Height | Width | Depth | Height | Depth | |
| FLIXBCNR | Flix Corner Seater Standard Back | 780 | 710 | 710 | 450 | 500 | 4 |
| FLIXSB1S | Flix 1 Seater Standard Back | 780 | 600 | 710 | 450 | 500 | 3.2 |
| FLIXSB2S | Flix 2 Seater Standard Back | 780 | 1200 | 710 | 450 | 500 | 3.9 |
| FLIXSB2.5S | Flix 2.5 Seater Standard Back | 780 | 1500 | 710 | 450 | 500 | 4.4 |
| FLIXSB3S | Flix 3 Seater Standard Back | 780 | 1800 | 710 | 450 | 500 | 5.1 |
| FLIXSB4S | Flix 4 Seater Standard Back | 780 | 2400 | 710 | 450 | 500 | 9 |
| FLIXSB45DEGCOB | Flix 1 Seater Curved OUTER Standard Back | 780 | 1045/500 | 710 | 450 | 500 | 5 |
| FLIXSB45DEGCIB | Flix 1 Seater Curved INNER Standard Back | 780 | 1045/500 | 710 | 450 | 500 | 3.8 |
| FLIXSBARM | Flix Arm (Single) to Suit 780 High | 780 | 90 | 710 | 450 | n/a | 1.6 |
| FLIXOTTO7160 | Flix Ottoman | 450 | 600 | 710 | 450 | 710 | 2.5 |
| FLIXOTTO45DEGC | Flix Ottoman 45 Degree Curved | 450 | 1080/530 | 710 | 450 | 710 | 3.2 |
| FLIXOTTO90DEGC | Flix Ottoman 90 Degree Curved | 450 | 2010/1000 | 710 | 450 | 710 | 4.9 |

Flix Standard Range

Fabric A Fabric B

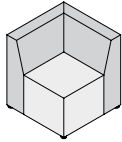

Corner Seater Standard Back
FLIXSBCNR

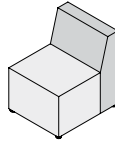

1 Seater Standard Back
FLIXSB1S

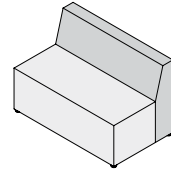

2 Seater Standard Back
FLIXSB2S

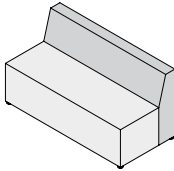

2.5 Seater Standard Back
FLIXSB2.5S

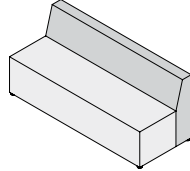

3 Seater Standard Back
FLIXSB3S

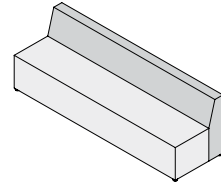

4 Seater Standard Back
FLIXSB4S

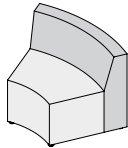

1 Seater Curved OUTER Standard Back
FLIXSB45DEGC0B

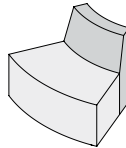

1 Seater Curved INNER Standard Back
FLIXSB45DEGCIB

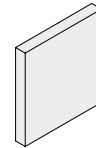

Arm (Single) to Suit 780 High
FLIXSBARM

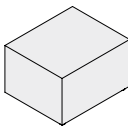

Ottoman
FLIXOTTO7160

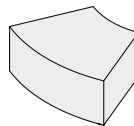

Flix Ottoman 45 Degree Curved
FLIXOTTO45DEGC

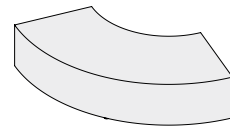

Flix Ottoman 90 Degree Curved
FLIXOTTO90DEGC

Configuration Options

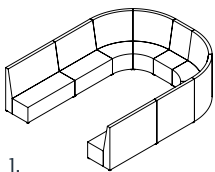

1.

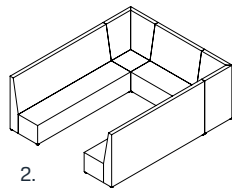

2.

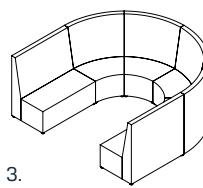

3.

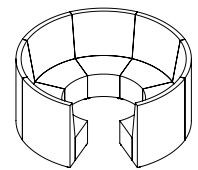

4.

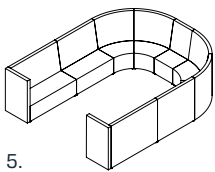

5.

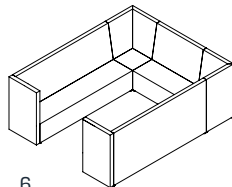

6.

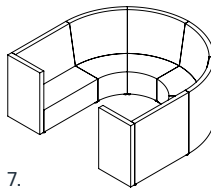

7.

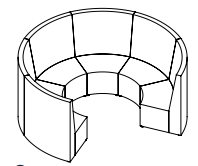

8.

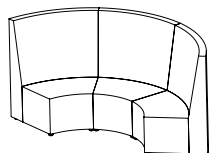

9.

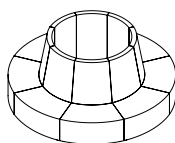

10.

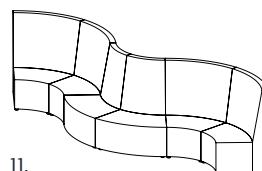

11.

Flix Tall

For added privacy, extra back and neck support, and comfort, the Flix is also available in a tall version. The height of the back provides a semi-enclosed, cocoon type working environment enabling persons to have 'their own space' amongst a busy workplace. The taller version is ideal for activities requiring heightened focus and concentration, or even phone discussions.

Feature Highlights

- Large range of modular configuration options for; Booth Seating, Banquet Seating, Arena Seating & Huddle spaces
- Option to add rectangular shaped arms and matching ottoman



1 Seater Curved OUTER Tall Back

Flix Tall

| Code | Description | External (mm) | | | Seat (mm) | | Meterage |
|----------------|--------------------------------------|---------------|-----------|-------|-----------|-------|----------|
| | | Height | Width | Depth | Height | Depth | |
| FLIXBCNR | Flix Corner Seater Tall Back | 1200 | 710 | 710 | 450 | 500 | 5.3 |
| FLIXTB1S | Flix 1 Seater Tall Back | 1200 | 600 | 710 | 450 | 500 | 4.2 |
| FLIXTB2S | Flix 2 Seater Tall Back | 1200 | 1200 | 710 | 450 | 500 | 5.6 |
| FLIXTB2.5S | Flix 2.5 Seater Tall Back | 1200 | 1500 | 710 | 450 | 500 | 6.4 |
| FLIXTB3S | Flix 3 Seater Tall Back | 1200 | 1800 | 710 | 450 | 500 | 7.4 |
| FLIXTB4S | Flix 4 Seater Tall Back | 1200 | 2400 | 710 | 450 | 500 | 8.6 |
| FLIXTB45DEGCOB | Flix 1 Seater Curved OUTER Tall Back | 1200 | 1045/500 | 710 | 450 | 500 | 4.7 |
| FLIXTB45DEGCIB | Flix 1 Seater Curved INNER Tall Back | 1200 | 1045/500 | 710 | 450 | 500 | 3.8 |
| FLIXTBARM | Flix Arm (Single) to Suit 1200 High | 1200 | 90 | 710 | 450 | n/a | 1.6 |
| FLIXOTTO7160 | Flix Ottoman | 450 | 600 | 710 | 450 | 710 | 2.5 |
| FLIXOTTO45DEGC | Flix Ottoman 45 Degree Curved | 450 | 1080/530 | 710 | 450 | 710 | 3.2 |
| FLIXOTTO90DEGC | Flix Ottoman 90 Degree Curved | 450 | 2010/1000 | 710 | 450 | 710 | 4.9 |

Flix Tall Range

Fabric A Fabric B

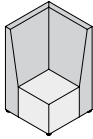

Corner Seater Tall Back
FLIXTBCNR

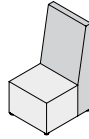

1 Seater Tall Back
FLIXTB1S

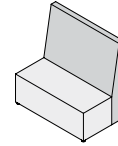

2 Seater Tall Back
FLIXTB2S

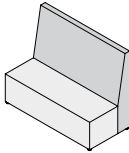

2.5 Seater Tall Back
FLIXTB2.5S

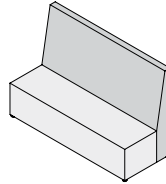

3 Seater Tall Back
FLIXTB3S

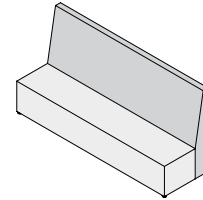

4 Seater Tall Back
FLIXTB4S

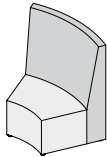

1 Seater Curved OUTER Tall Back
FLIXTB45DEGCOB

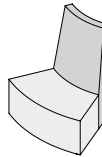

1 Seater Curved INNER Tall Back
FLIXTB45DEGCIB

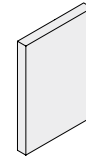

Arm (Single) to Suit 1200 High
FLIXTBARM

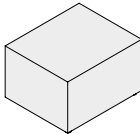

Ottoman
FLIXOTTO7160

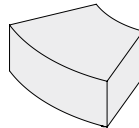

Flix Ottoman 45 Degree Curved
FLIXOTTO45DEGC

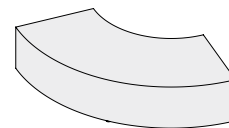

Flix Ottoman 90 Degree Curved
FLIXOTTO90DEGC

Configuration Options

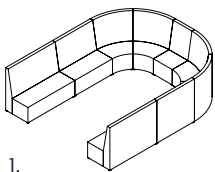

1.

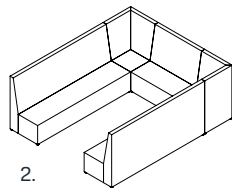

2.

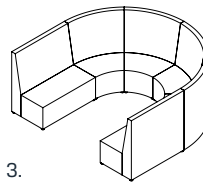

3.

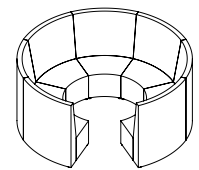

4.

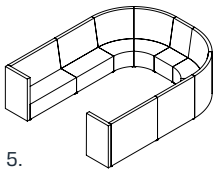

5.

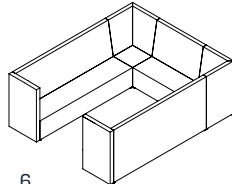

6.

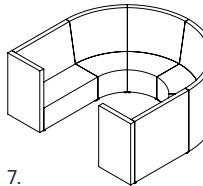

7.

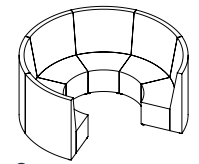

8.

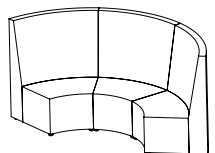

9.

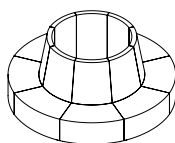

10.

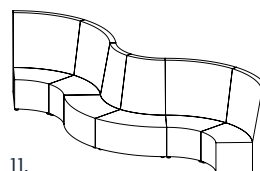

11.

Flo Standard

Flo modular seating is ideally formed in a large sitting area where teams work, relax or collaborate. Flo is an eye-catching design mounted on 120mm high chrome feet that shouts creativity. The standard back option with the addition of a matching ottoman provides an open invitation for group collaboration. The tall back alternative forms creative hubs for added seclusion, concentration and privacy.

Feature Highlights

- Large range of modular configuration options
- Options to add rectangular shaped arms and matching ottoman
- Modern design with 120mm high feet

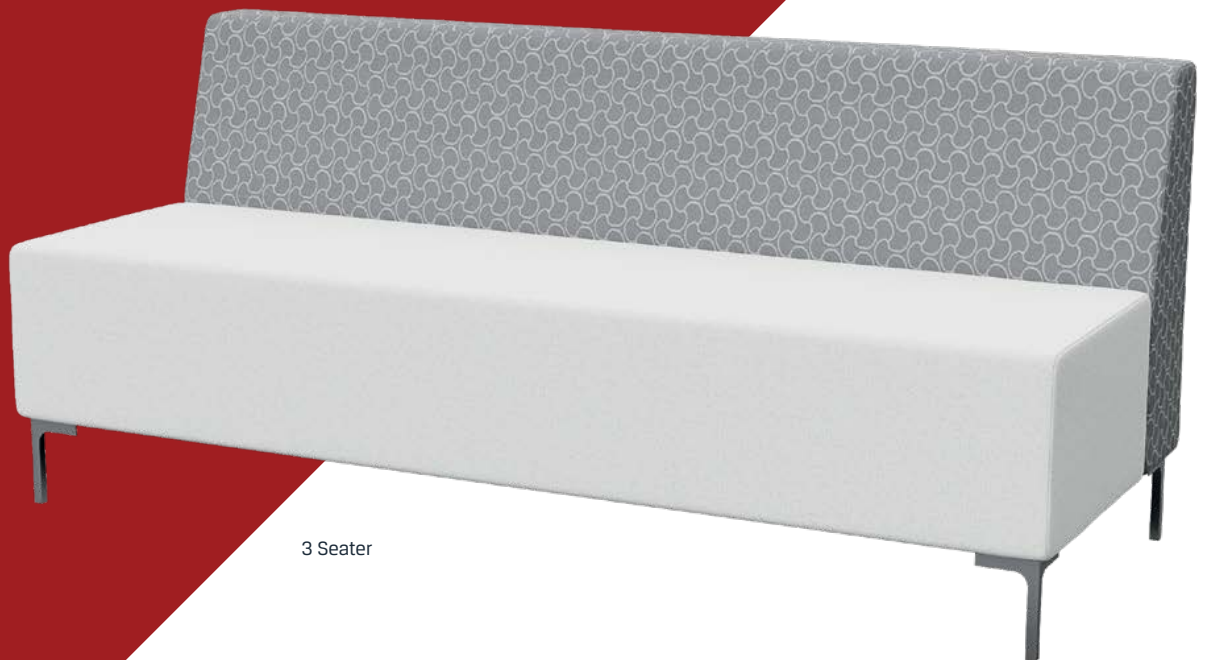

3 Seater

Flo Standard

| Code | Description | External (mm) | | | Seat (mm) | | Meterage |
|---------------|--|---------------|-------|-------|-----------|-------|----------|
| | | Height | Width | Depth | Height | Depth | |
| FL01 | Flo 1 Seater Standard Back | 780 | 600 | 710 | 450 | 500 | 2.2 |
| FL02 | Flo 2 Seater Standard Back | 780 | 1200 | 710 | 450 | 500 | 2.9 |
| FL02.5 | Flo 2.5 Seater Standard Back | 780 | 1500 | 710 | 450 | 500 | 3.4 |
| FL03 | Flo 3 Seater Standard Back | 780 | 1800 | 710 | 450 | 500 | 4.1 |
| FL04 | Flo 4 Seater Standard Back | 780 | 2400 | 710 | 450 | 500 | 8 |
| FLOCNR | Flo Corner Seater Standard Back | 780 | 710 | 710 | 450 | 500 | 3 |
| FL01A | Flo 1 Seater Standard Back with Arms | 780 | 780 | 710 | 450 | 500 | 4 |
| FL02A | Flo 2 Seater Standard Back with Arms | 780 | 1380 | 710 | 450 | 500 | 4.7 |
| FL02.5A | Flo 2.5 Seater Standard Back with Arms | 780 | 1580 | 710 | 450 | 500 | 5.2 |
| FL03A | Flo 3 Seater Standard Back with Arms | 780 | 1980 | 710 | 450 | 500 | 5.9 |
| FL04A | Flo 4 Seater Standard Back with Arms | 780 | 2580 | 710 | 450 | 500 | 9.8 |
| FL00TT0710600 | Flo Ottoman 710 x 600 | 450 | 600 | 710 | 450 | 710 | 2 |
| FL00TT0710710 | Flo Ottoman 710 x 710 | 450 | 710 | 710 | 450 | 710 | 2 |



1 Seater



2 Seater with arms



Ottoman 710 x 600mm

Flo Standard Range

Fabric A Fabric B

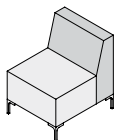

1 Seater Standard Back
FL01

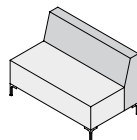

2 Seater Standard Back
FL02

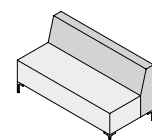

2.5 Seater Standard Back
FL02.5

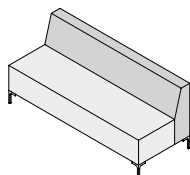

3 Seater Standard Back
FL03

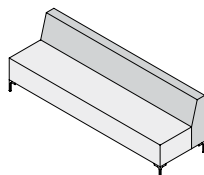

4 Seater Standard Back
FL04

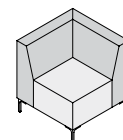

Flo Corner Seater Standard Back
FLOCNR

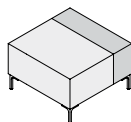

Flo Ottoman 710 x 600
FL00TT0710600

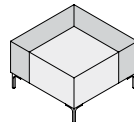

Flo Ottoman 710 x 710
FL00TT0710710

* Option to add arms.

Flo Tall

For added privacy, extra back and neck support, and comfort, the Flo is also available in a tall version. The height of the back provides a semi-enclosed, cocoon type working environment enabling persons to have 'their own space' amongst a busy workplace. The taller version is ideal for activities requiring heightened focus and concentration, or even phone discussions.

Feature Highlights

- Large range of modular configuration options
- Options to add rectangular shaped arms and matching ottoman
- Modern design with 120mm high feet



Flo Tall

| Code | Description | External (mm) | | | Seat (mm) | | Meterage |
|---------------|------------------------------------|---------------|-------|-------|-----------|-------|----------|
| | | Height | Width | Depth | Height | Depth | |
| FLO1STB | Flo 1 Seater Tall Back | 1200 | 600 | 710 | 450 | 500 | 3.2 |
| FLO2STB | Flo 2 Seater Tall Back | 1200 | 1200 | 710 | 450 | 500 | 4.6 |
| FLO2.5STB | Flo 2.5 Seater Tall Back | 1200 | 1500 | 710 | 450 | 500 | 5.4 |
| FLO3STB | Flo 3 Seater Tall Back | 1200 | 1800 | 710 | 450 | 500 | 6.4 |
| FLO4STB | Flo 4 Seater Tall Back | 1200 | 2400 | 710 | 450 | 500 | 9.2 |
| FLOCNRTB | Flo Corner Seater Tall Back | 1200 | 710 | 710 | 450 | 500 | 4.6 |
| FLO1STBA | Flo 1 Seater Tall Back with arms | 1200 | 780 | 710 | 450 | 500 | 6.6 |
| FLO2STBA | Flo 2 Seater Tall Back with arms | 1200 | 1380 | 710 | 450 | 500 | 8.0 |
| FLO2.5STBA | Flo 2.5 Seater Tall Back with arms | 1200 | 1580 | 710 | 450 | 500 | 8.8 |
| FLO3STBA | Flo 3 Seater Tall Back with arms | 1200 | 1980 | 710 | 450 | 500 | 9.8 |
| FLO4STBA | Flo 4 Seater Tall Back with arms | 1200 | 2580 | 710 | 450 | 500 | 12.6 |
| FLO0TT0710600 | Flo Ottoman 710 x 600 | 450 | 600 | 710 | 450 | 710 | 2 |
| FLO0TT0710710 | Flo Ottoman 710 x 710 | 450 | 710 | 710 | 450 | 710 | 2 |



PROUDLY AUSTRALIAN MADE



1 seater



2.5 seater with arms



Corner Seater Tall Back



Ottoman 710 x 710mm

Flo Tall Range

Fabric A Fabric B

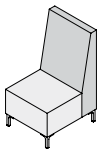

1 Seater Tall Back
FLO1STB

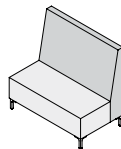

2 Seater Tall Back
FLO2STB

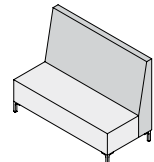

2.5 Seater Tall Back
FLO2.5STB

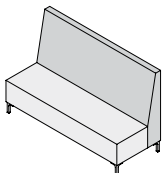

3 Seater Tall Back
FLO3STB

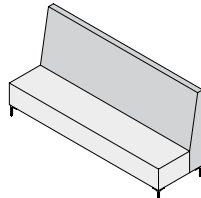

4 Seater Tall Back
FLO4STB

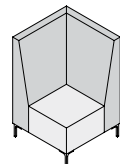

Flo Corner Seater Tall Back
FLOCNRTB

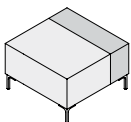

Flo Ottoman 710 x 600
FLO0TT0710600

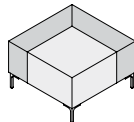

Flo Ottoman 710 x 710
FLO0TT0710710

* Option to add arms.

House Colour Range

The **Cashmere** fabric range, by Wortley Group, is a beautifully soft, textured plain woven in 100% Polyester. Featuring a lightly brushed surface, Cashmere is a soft yet high performance textile suitable for commercial applications.



Dove



Silver Dust



Pebble



Almond



Leaf



Marigold



Nero



Azalea

Note: Due to many factors, but not limited to the following: customer monitor calibration and printing processes colours represented within this brochure are indicative only. Please request a sample swatch if unsure about colour accuracy.





Imperial



Pimento



Haze



Mineral



Purple



Peacock

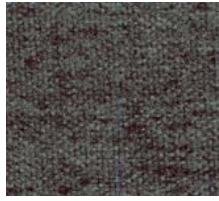

Pewter



Walnut







PROUDLY
AUSTRALIAN
MADE





Embrace the modern
day workplace and
activity-based
working today.

Nexus Interiors

12/324 Settlement Rd, Thomastown Vic 3074

Phone (03) 9348 2000

Fax (03) 8677 2899

Email sales@nexusinteriors.com.au

Website nexusinteriors.com.au